

Hisense

USER MANUAL

Read the manual carefully and ensure you have fully understood its contents before operating this device for the first time.

English

Deutsch

Español

Italiano

Português

Français

ES-A160924-1

Hisense

USER MANUAL

Read the manual carefully and ensure you have fully understood its contents before operating this device for the first time.

English

Important Notice

Paragraphs beginning with the symbol  indicate important instructions, tips or conditions for the following settings.

 **For your own safety and the optimal performance of your TV, ensure to read the safety instructions before performing any installation.**

Hisense does not guarantee operation and performance of peripheral devices made by other manufacturers. We disclaim any liability or damage that may arise from operation and/or performance from usage of such other maker's peripheral devices.

The recording and playback of content on this or any other device may require permission from the owner of the copyright or other such rights in that content. It is your responsibility to ensure that your use of this or any other device complies with applicable copyright legislation in your country. Please refer to that legislation for more information on the relevant laws and regulations involved or contact the owner of the rights of the content you wish to record or playback.

The Index/Glossary explains certain terms used in this user manual and in the TV menu.

Declaration of Conformity (DoC)

This TV is CE marked and complies with EU directives. The complete declaration of conformity is included in this manual, and can also be downloaded from the Hisense homepage.

Hisense declares that this TV is in compliance with the essential requirements and other relevant provisions of Directive 1999/5/EG. It may be operated in all countries in the EU and also Iceland, Norway and Switzerland. In France and Italy it may only be used indoors.

Read these instructions

Follow all instructions

Heed all warnings

Keep these instructions

All rights reserved.



Safety Instructions

To ensure safe and correct use of this product, always comply with the following precautions to avoid dangerous situations and damage to your unit:

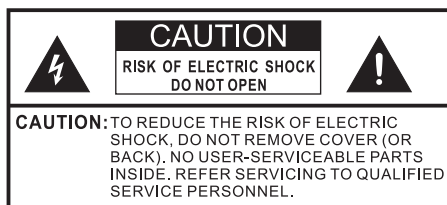

The lightning flash with arrowhead symbol, within an equilateral triangle is intended to alert the user to the presence of uninsulated dangerous voltage within the product's enclosure that may be of sufficient magnitude to constitute a risk of electric shock.



The exclamation point within an equilateral triangle is intended to alert the user to the presence of important operating and maintenance (servicing) instructions in the literature accompanying the appliance.

The intended use and ambient conditions for this TV

This TV is intended for the rendering of video and audio signals, on a table-top or wall-mounted, in a home or office environment. It must not be used in rooms with a high level of humidity or dust concentration. The warranty is only valid if used as intended by the manufacturer.



WARNING

High humidity and dust concentration may lead to current leaks in the device. To reduce the risk of fire or electrical shock:

- **Do not expose this unit to rain, moisture, dripping or splashing water, and do not place objects filled with liquids, such as vases, cups, etc. on or over the unit.**
- **Do not touch the TV with wet hands.**
- **Do not expose to direct air-conditioning and keep candles or other naked flames away from the TV at all times.**

If the TV is moved from a cold environment to a hot environment, leave it switched off for at least an hour to avoid condensation. If used outside, make sure it is protected from moisture.

If you notice anything unusual, immediately turn off the main power supply switch and remove the power plug.

In case of fire, use preferably a CO₂ gas or powder fire extinguisher. If such extinguishers are not accessible, try to isolate the electrical supply before using a water fire extinguisher.

Important Safety Instructions

■ Moving/Transportation

Before moving this TV, disconnect all cables and move in the vertical position only. Grasp the device on the upper and lower edges of the frame.

- Do not press or put stress on the front panel of the TV. It may take two or more people to carry larger TVs.

If you have to briefly lay down the TV, place the unit with its entire front surface lying flat on soft material.

The LED screen is made of glass and can break if is not handled properly. Always wear rubber gloves to carry the unit. If the LED screen is damaged, liquid crystal might leak out. In case of skin contact, immediately rinse thoroughly with water.

■ Power Supply

Incorrect voltages can damage the TV. Only connect this unit to a power supply with the correct voltage and frequency noted on the type plate, using the supplied power cable.

The power plug must be easily accessible so that the device can be disconnected at all time. The unit is live, even if the I/O button is switched off, as long as the unit is connected to a power outlet.

It is recommended that this unit is placed on a dedicated circuit.

- Do not overload the power outlets by connect too many appliances to the same outlet. Overloaded wall outlets, extension cords, etc. are dangerous and can result in electric shock and fire.

After power off, don't turn it on again in 5 seconds. Frequent switching power supply in a short period of time can cause abnormal TV.

■ Power plug and power cable

- Do not touch the power plug with wet hands.
- Do not place heavy objects on the power cable. Route the cable so that it is not kinked or laid over sharp edges, walked on or exposed to chemicals. A power cable with damaged insulation can cause electric shock and fire.
- Pull the power plug, NOT on the cable when disconnecting. The cable can become damaged and cause a short circuit if pulled on.
- Do not place the power cable near a high temperature object.
- Do not move the TV with the power cable plugged into a socket.
- Do not use a damaged or loose power cable, or a damaged socket outlet.
- Do not use any power cords other than the one supplied with this unit.

■ Set-up

Check that the location is suitable to bear the load of the TV. Place on a level, sturdy and horizontal base. Ensure that the unit does not hang over the edge of the base when placed in or on furniture. If placed on a cart, use caution when moving to avoid the unit from tipping over.

- Place the unit in a normal upright horizontal position. It must never be operated vertically, lying flat or hanging overhead from the ceiling.
- Place the unit where it is not exposed to direct sunlight or other sources of heat.

When mounting the TV on a wall, follow the instructions supplied with the wall-mount, make sure not to install the TV by hanging the power and signal cables on the back of the TV.

Important Safety Instructions

■ Air ventilation and high temperatures

Install your TV only where there is proper ventilation, and ensure that there is at least 10 cm free space on the sides and 20 cm above the unit for air circulation. Excessive heat and obstruction of ventilation could lead to fire or early failure of some electric components.

- Do not block any ventilation openings with newspapers, tablecloths, curtains, etc.
- Do not dry clothing etc. on top of the unit.
- Take care not to touch the ventilation openings since they may become hot.
- Do not insert foreign objects into the TV through the vents.

■ The Stand

- Do not use any stand other than the one supplied with this unit.
- Do not modify or use the stand if it becomes warped or physically damaged.
- During setup, make sure that all the screws are securely tightened.
- Ensure that the TV does not suffer any impact during the attachment of the stand.
- Ensure that children do not climb onto the stand.
- Attach or remove the stand with at least two people.

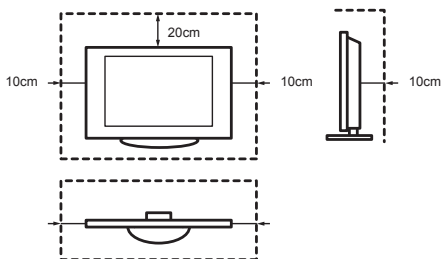

Prevent small items from getting into the interior of the device through the ventilation slots. Such objects may cause short circuits, which may cause fire.

If something should get inside the unit, immediately unplug the power plug of the device and contact service support.

■ The LED screen

Despite thorough care when manufacturing this display, it cannot be 100% guaranteed that no sub-pixel defects will occur due to technical reasons. These cannot be considered as a device defect in terms of the guarantee. They will not affect the performance and reliability of the TV.

To prevent "image burn", avoid displaying still images for long periods of time, there is a possibility that a copy of the image may remain. If the aspect ratio is set to 4:3 for a long period of time, image burn may occur on the black areas. Image burn is not covered by the warranty.

- Do not apply strong force or impact on the display panel.

Avoid touching the LED screen or touching it for long periods of time. Doing so may produce some temporary distortion effects on the screen.

Important Safety Instructions

■ Radio waves

- Do not use the TV in any medical institutions or locations with medical equipment. Radio waves may interfere with medical equipment and cause malfunction.
- Do not use the TV near any automatic control equipment such as automatic doors or fire alarms. Radio waves may interfere with automatic control equipment and cause malfunction.

If you have a cardiac pacemaker, keep a distance of at least 22 cm from the TV. Radio waves may interfere with the operation of a pacemaker.

■ Built-in wireless LAN

- Do not connect to wireless networks that you do not have the usage rights for. Data transmitted and received over radio waves may be intercepted and monitored.

The built-in wireless LAN uses 2.4 GHz and 5 GHz frequency bands. To avoid malfunctions or slow response caused by radio wave interference, keep the TV away from devices such as other wireless LAN devices, microwaves, mobile phones, and other devices that use 2.4 and 5 GHz signals.

■ Supervision

- Do not let children play unsupervised close to the TV. It could tip over, be pushed off or pulled down from the stand surface and injure someone.
- Do not allow a switched-on TV to run unattended.

■ Volume

Loud music and noises can lead to irreversible damage to your ears. Avoid extreme volume, especially over long periods and when using headphones.

If you hear a drumming noise in your ears, turn down the volume or temporarily stop using headphones.

■ Thunder Storms

Pull out the power plug and all connected antenna cables from the TV during a thunderstorm. Overvoltage caused by lightning strikes can damage the TV via the antenna system, as well as the wall socket.

■ Long periods of absence

As long as the power plug is connected to a live socket outlet, the TV will consume power even in "OFF"-mode. The power plug and all connected antenna cables should be disconnected out during long periods of absence.

Important Safety Instructions

■ Cleaning and care

CAUTION:

Unplug the power cord prior to cleaning the TV.

Clean the TV, the screen, and the remote control with a soft, moist, clean and color-natural cloth only. Do not use any chemicals.

- Do not subject the surfaces to insect repellent, solvent, thinner or other volatile substances. This may degrade the surface quality.
- Do not spray water or other liquids directly on the TV. Liquid inside the TV could lead to product failure.
- The surface of the display panel is treated and may be easily damaged. Take care not to scratch it with fingernails or other hard objects.
- Also wipe the power plug with a dry cloth at regular intervals

■ Service/Repair

Never remove the cover/back of the TV; there are no user serviceable parts inside. Refer all service to qualified service personnel.

■ Packaging

Keep the anti-moisture materials and plastic bags out of reach of children.

Plastic bags can cause suffocation and the anti-moisture material is harmful if swallowed. If swallowed by mistake, force the patient to vomit and visit the nearest hospital.

■ Modification

Do not attempt to modify this product in any way. Unauthorized modification could void the warranty of this unit, cause electric shock and fires.

■ Remote Control batteries

- Incorrect installation may cause battery leakage, corrosion and explosion.
- Replace only with the same or equivalent type.
- Do not mix old and new batteries.
- Do not mix different battery types
- Do not use rechargeable batteries
- Do not burn or break up batteries.
- Do not expose batteries to excessive heat
- Be sure to dispose of batteries correctly

■ Outdoor Antenna Grounding

If an outdoor antenna used, be sure the antenna system is protected against voltage surges and built-up static charges.

■ Disposal

Refer to the recycling section of this manual.

Contents

Please visit Hisense official website for more details.

Product image is only for reference, actual product may vary in appearance.
Parts of the software function changes with the system upgrade.

Contents

Accessories List.....	1
Installing the Stand	2
TV Front.....	3
TV Rear	4
Making Connections	5
Remote Control	11
Turning the TV on for the First Time.....	13
Specifications	14
Other Information.....	15

Accessories List

The following accessories are included with TV:

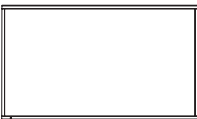

TV

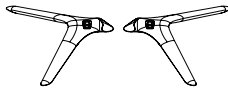

Base Stand



Column Base



User Manual



European Guarantee



screw × 8



Remote Control



AAA Batteries × 2

Installing the Stand

Installing the Stand

⚠ CAUTION

- Be sure to disconnect the A/C power cord before installing a stand or Wall-Mount brackets.
- The LED display is very fragile, and must be protected at all times when installing the base stand. Be sure that no hard or sharp object, or anything that could scratch or damage the LED display, comes into contact with it. DO NOT exert pressure on the front of the TV at any time because the screen could crack.

Follow the illustrations and textual instructions below to complete the installation steps:

1. Carefully place your TV face-down on a soft, flat surface to prevent damage to the TV or scratching to the screen.

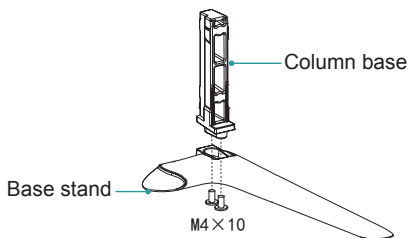

2. Secure the Column base to the Base stand with the 2 screws in accessory tightly.

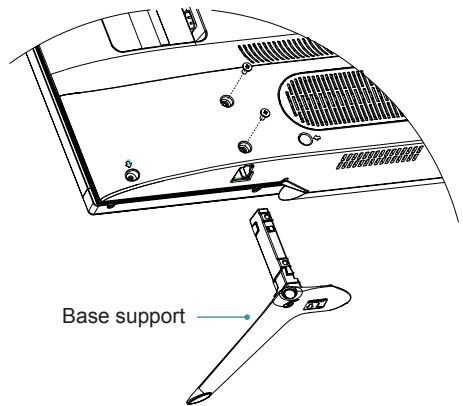

3. Align the Base support with the screw holes on the bottom of TV BACK, secure the BASE support to the TV with the 2 screws in accessory tightly.

📌 NOTE

Product images are only for reference, actual product may vary in appearance.

TV Front

TV Front

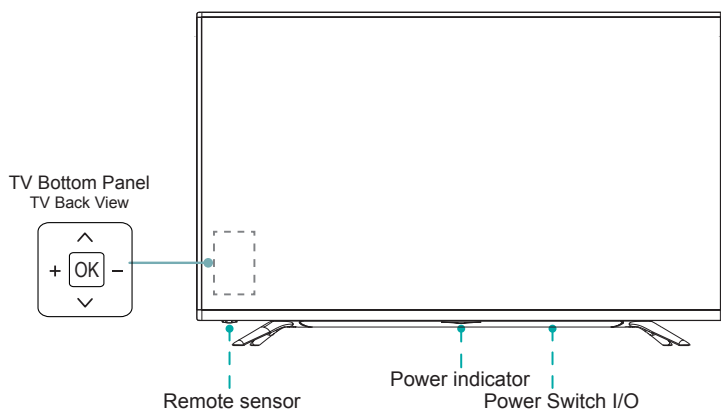

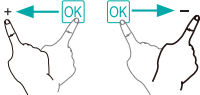
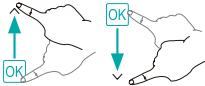
Item	Description
Remote sensor	Receives remote signals from the remote control. Do not put anything near the sensor, as its function may be affected.
Power switch	Turn the main power ON or OFF.
Power indicator	The light is used for indicating.
	Select among the different input signal sources and put the TV in standby mode, and you can turn on the TV when the TV in standby mode.
	Toggle the OK button left and right to adjust the volume.
	Toggle the OK button up and down to select the channel.

NOTES

- The Picture is Only for Reference.
- Powering on the TV requires several seconds to load program. Do not rapidly turn the TV off as it may cause the TV to work abnormally.
- Power indicator's default setting of different models may vary.

TV Rear

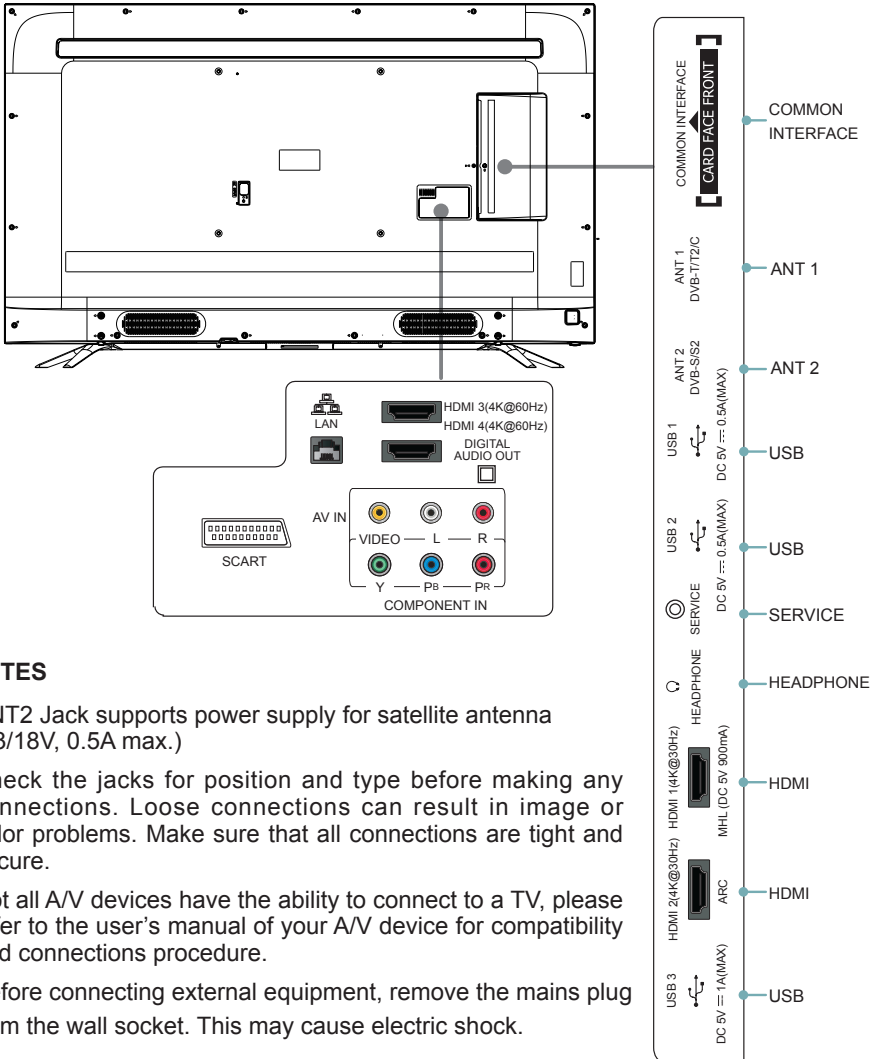

NOTES

- ANT2 Jack supports power supply for satellite antenna (13/18V, 0.5A max.)
- Check the jacks for position and type before making any connections. Loose connections can result in image or color problems. Make sure that all connections are tight and secure.
- Not all A/V devices have the ability to connect to a TV, please refer to the user's manual of your A/V device for compatibility and connections procedure.
- Before connecting external equipment, remove the mains plug from the wall socket. This may cause electric shock.

Making Connections

▶ LAN (Wired setup)

Connect your TV to your network by connecting the LAN port on the back of your TV to an external modem or router using a LAN (Ethernet/Cat 5) cable. See the illustration below.

- We recommend to use a modem or router that supports Dynamic Host Configuration Protocol (DHCP). Modems and routers that support DHCP automatically provide the IP address, subnet mask, gateway, and DNS, so you don't have to enter them manually. Most home networks already have DHCP.

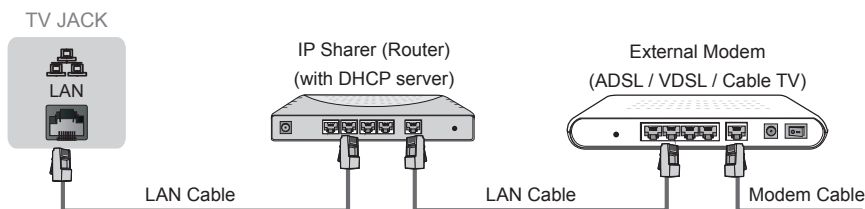

Wireless setup

Connect your TV to your network wirelessly, you need a wireless router or modem. See the illustration below.

- The built-in Wireless LAN Adapter supports the IEEE 802.11 b/g/n communication protocols. We recommend using IEEE 802.11n router. Low transfer rates for b/g may have the influence on the quality of streamed videos and other media.

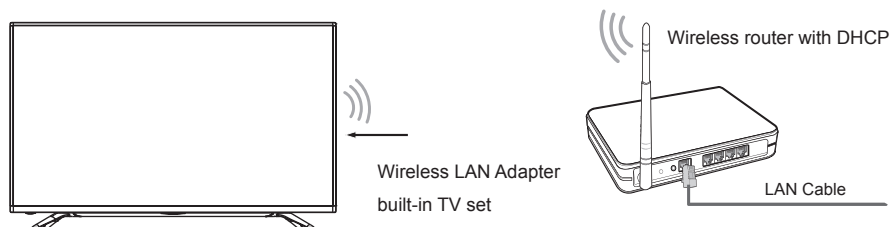

☒ NOTES

- You must use the built-in Wireless LAN Adapter to use a wireless network because the set doesn't support external USB network adapter.
- If the wireless router supports DHCP, your TV can connect more easily to the wireless network.
- If you apply a security system other than the systems listed below, it will not work with the TV.
security system: WPA, WEP, WPA2.
- In order to guarantee smooth network, the distance between router and TV is less than 10 meters.

Making Connections

- ▶ **HDMI 1(MHL)** Connect an MHL cable (not provided) from your MHL-enabled device, such as a cell phone.

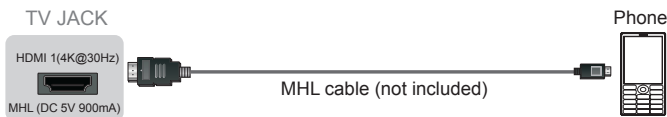

- ▶ **HDMI 2(ARC)** Connect an HDMI cable from an external digital audio system. ARC enables the TV to directly output the digital sound through an HDMI cable. Please note that it works only when the TV is connected to the audio receiver that supports the ARC (Audio Return Channel) function.

When this port is used as the ARC function, it can't be used as signal input at the same time.

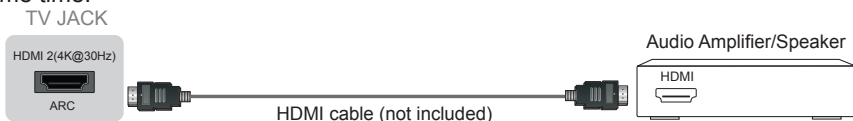

- ▶ **HDMI** Connect an HDMI cable from an external A/V equipment. Some devices such as PVR or DVD player require HDMI signal to be set to output in the device's settings. Please consult your device user manual for instructions. Please note that the HDMI connector provides both video and audio signals, it's not necessary to connect an audio cable.

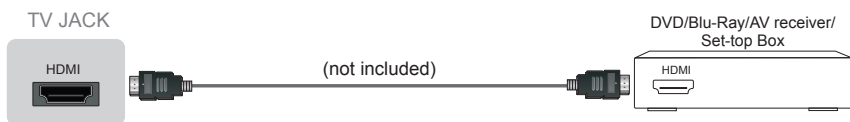

NOTES

- Sources of UHD (4K) content must be connected to the HDMI1 / HDMI2 / HDMI3 / HDMI4 input.
- The repetition rate is fixed at 100%, and it can not be adjusted.

Making Connections

- ▶ **ANT** Connect an outdoor VHF/UHF antenna or cable.

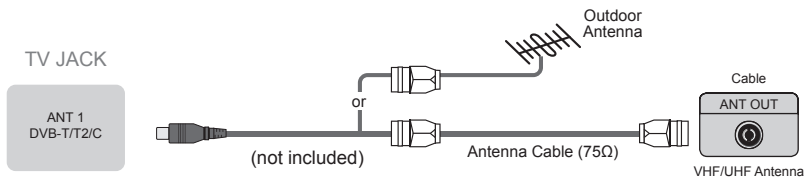

- ▶ **ANT** Connecting a satellite antenna.

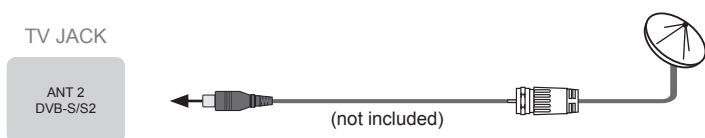

- ▶ **HEADPHONE** Connect Headphone for audio out of the TV.

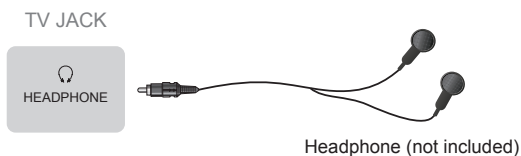

- ▶ **SCART** Connect a Scart cable.



Making Connections

► USB

Connect the USB devices such as hard drives, USB sticks and digital cameras for browsing photos, listening music and watching recorded movies. You can use Timeshift and record (refer to “PVR/Timeshift”). At the same time update is also an easy thing and will be done just by plugging the USB with the updating files into the same interface.

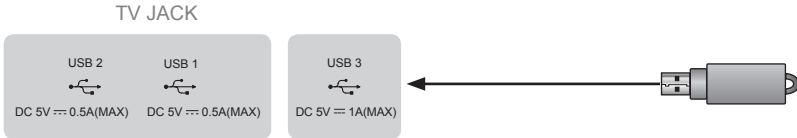

📄 NOTES

- When connecting a hard disk or a USB hub, always connect the mains adapter of the connected device to the power supply. Exceeding a total current consumption may result in damage. The USB1.1 and USB2.0 devices maximum current consumption are 500mA. The USB3.0 device maximum current consumption is 1A.
- For individual non-standard high-capacity mobile hard disk, if it's impulse current is greater than or equal 1A, it may cause TV-rebooting or self-locking. So the TV does not support it.
- The USB port supports a voltage of 5V.
- The maximum supported storage space of the hard disk is 1T.
- If you want to store the video streaming of a DTV program, the transfer rate of the USB storage device must not be less than 5MB/s
- Since the function record temporary the program onto a hard disk only. Please connect a hard disk which its storage capacity is no less than 8G.

Making Connections

▶ COMMON INTERFACE

Insert the CI+ module for watching scrambled services like pay-tv channels or some HD channels.

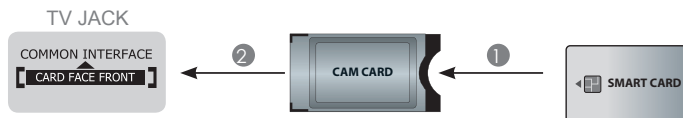

➔ NOTES

- Before you insert/remove the CI+ module, ensure that the TV is switched off. Then insert the CI card into the CI+ module in accordance with the Service Provider's instructions.
- Do not repeatedly insert or remove the Common Access Module as this may damage the interface and cause a malfunction.
- You must obtain a CI+ module and card from the service provider of the channels you want to watch.
- Insert the CI+ module with the SmartCard in the direction marked on the module and SmartCard.
- CI+ is not supported in some countries and regions; check with your authorized dealer.

▶ DIGITAL AUDIO OUT Connect to an external digital audio device.

Before connecting a digital audio system to the DIGITAL AUDIO OUT jack, you should decrease the volume of both the TV and the system to avoid that the volume suddenly become bigger.

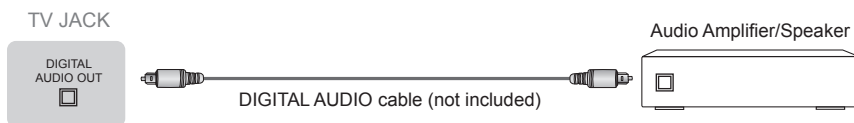

Making Connections

- ▶ **COMPONENT IN** Connect a component cable and an audio cable from an external A/V Device.

The component output ports Y, P_B and P_R on the VCD or DVD can sometimes be identified as Y, C_B and C_R.

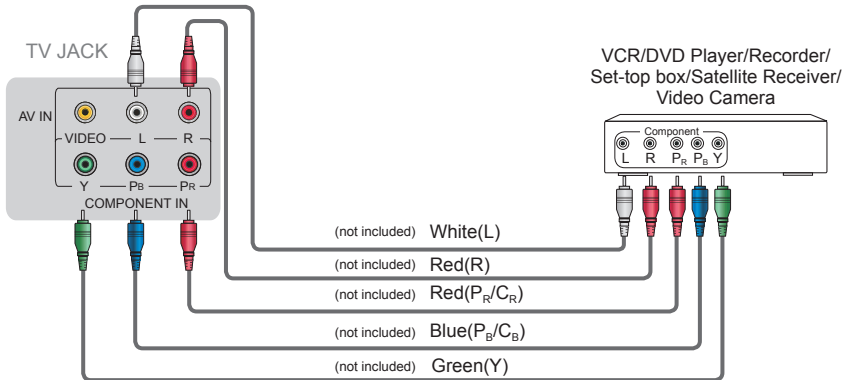

- ▶ **AV IN** Connect the Composite cable from an external A/V Device.

Use the audio and video cables to connect the external A/V device's composite video/audio jacks to the TV's jacks. (Video = yellow, Audio Left = white, and Audio Right = red)

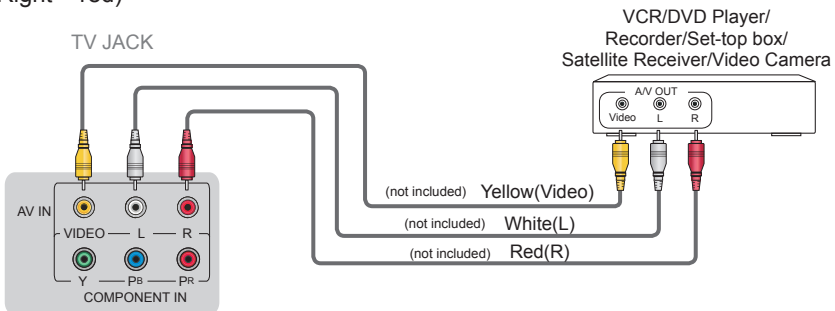

Remote Control

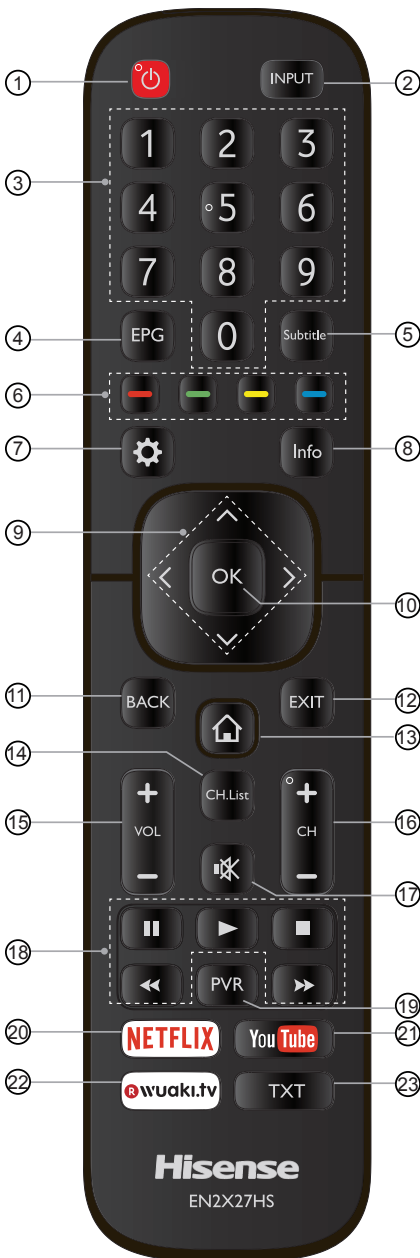

- ① POWER: Switch the TV on or into standby mode
- ② INPUT: Select input sources
- ③ Channel Number: Direct channel selection or numbers input
- ④ EPG: Display the Electronic Program Guide (DTV mode)
- ⑤ Subtitle: Activate or deactivate the subtitle mode
- ⑥ Color keys for direct selection of options
- ⑦ SETTING: Display the Settings menu
- ⑧ Info: Display the present program information such as the current channel and the input source
- ⑨ $\wedge / \vee / \lt / \gt$: Allows you to navigate the OSD menus and adjust the system settings to your preference
- ⑩ OK: Confirm the selection in the OSD menus
- ⑪ BACK: Return to previous menu
- ⑫ EXIT: Exit the menu
- ⑬ HOME: Enter the Smart
- ⑭ CH.List: Display the Channel List on the screen
- ⑮ VOL + / -: Adjust the volume
- ⑯ CH + / -: Switch channel
- ⑰ MUTE: Mute or restore the TV sound
- ⑱ Playback and record keys
- ⑲ PVR: Record the current program (DTV mode)
- ⑳ NETFLIX: Press to launch NETFLIX instant video streaming
- ㉑ YouTube: Enter the YouTube app
- ㉒ Wuaki.tv: Enter the Wuaki.tv
- ㉓ TXT: Turn on/off the teletext function

► Installing Batteries in the Remote Control

1. Slide the back cover to open the battery compartment of the remote control.
2. Insert two AAA size batteries. Make sure to match the (+) and (-) ends of the batteries with the (+) and (-) ends indicated in the battery compartment.
3. Close the battery compartment with the cover.

❶ Gently push and slide

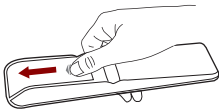

❷ Insert the batteries

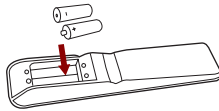

❸ Gently push and slide

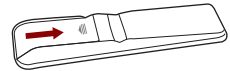

📌 NOTES

- Product image is only for reference, actual product may vary in appearance.

Handling the Batteries

- Incorrect use of batteries may cause corrosion or battery leakage, which could cause fire, personal injury or damage to property.
- Only use the battery type indicated in this manual
- Do not mix old and new batteries or different types of batteries .
- Do not dispose of used batteries as domestic waste. Dispose of them in accordance with local regulations.

► Remote Control Operation Range

1. Point the remote control at the TV within no more than 6 metres from the remote control sensor on the TV and within 60° in front of the TV.
2. The operating distance may vary depending on the brightness of the room.

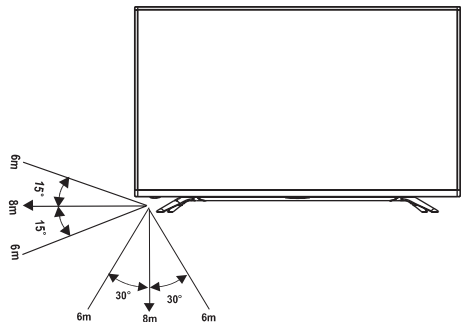

Turning the TV on for the First Time

Turning the TV on for the First Time

1. Connect the mains cable to the mains socket after you have completed all the connections.
2. The first time you turn the TV on, it will go straight into the Installation Guide. It will assist you to specify the Language, Location, Network.
3. Press the [**^** / **v** / **<** / **>**] to navigate the menu and change the settings. Press the [**OK**] button to confirm.

Language	Select your desired language to be displayed on the menu.
Location	Select the location where you will operate the TV.
Network	Accept EULA Help promote the TV user experience. If your TV does not automatically detect an Ethernet connection, then select Change to Wireless . When you're done, select your network from the list that displays and move to the next screen.
Complete	You have completed the Wizard setup, please select the desired mode.

Specifications

☑ Features, appearance and specifications are subject to change without notice.

Model Name		65"
Dimension	Without Stand	Width: 57.4 inches (1458 mm) Height: 33.6 inches (854 mm) Depth: 2.4 inches (62 mm)
	With Stand	Width: 57.4 inches (1458 mm) Height: 35.4 inches (898 mm) Depth: 12.4 inches (315 mm)
Weight	Without Stand	66.1 lbs (30 kg)
	With Stand	68.3 lbs (31 kg)
Active Screen Size (Diagonal)		163cm
Screen resolution		3840 × 2160
Audio power		15W +15W
Power consumption		Please refer to the rating label.
Power supply		Please refer to the rating label.
Receiving systems	Analog	PAL-D/K, B/G, I, SECAM-D/K, B/G, L/L'
	Digital	DVB-T/T2, DVB-C, DVB-S/S2
Environmental conditions		Temperature: 41°F - 95°F (5°C - 35°C) Humidity: 20% - 80% RH Atmospheric pressure: 86 kPa - 106 kPa
Component Input		480 I / 60 Hz, 480 P / 60 Hz, 576 I / 50 Hz, 576 P / 50 Hz, 720 P / 50 Hz, 720 P / 60 Hz, 1080 I / 50 Hz, 1080 I / 60 Hz, 1080 P / 50 Hz, 1080 P / 60 Hz
HDMI Input		HDMI1, HDMI2: RGB / 60 Hz (640×480, 800×600, 1024×768) YUV / 60 Hz (480 I, 480 P, 720 P, 1080 I, 1080 P) YUV / 50Hz (576 I, 720 P, 1080 I, 1080 P) 3840×2160/24Hz, 3840×2160/25Hz, 3840×2160/30Hz HDMI3, HDMI4: RGB / 60 Hz (640×480, 800×600, 1024×768) YUV / 60 Hz (480 I, 480 P, 720 P, 1080 I, 1080 P) YUV / 50Hz (576 I, 720 P, 1080 I, 1080 P) 3840×2160/24Hz, 3840×2160/25Hz, 3840×2160/30Hz, 3840×2160/50Hz, 3840×2160/60Hz

Recycling/Licenses

WEEE (Waste Electronic Electric Equipment) European Directive 2012/19/EU



This symbol on the product or on its packaging indicates that this product must not be disposed of with your household waste. Instead, it is your responsibility to dispose of your waste equipment by handing it over to a designated collection point for the recycling of waste electrical and electronic equipment. The separate collection and recycling of your waste equipment at the time of disposal will help to conserve natural resources and ensure that it is recycled in a manner that protects human health and the environment. For more information about where you can drop off your waste equipment for recycling, please contact your local city office, your household waste disposal service or the shop where you purchased the product.

Batteries



In accordance with the Battery Directive, used batteries should not be disposed of in the domestic waste. Dispose your batteries in the collection containers specific for this purpose in retail stores.

ROHS (Restriction of Hazardous Substance) European Directive 2011/65/EU



This European directive limits the use of dangerous and hazardous substances which are difficult to recycle.

This allows recycling easily the EEE and contributes to the safeguard of the environment.

Substances included in this product match to the RoHS directive.



The terms HDMI and HDMI High-Definition Multimedia Interface, and the HDMI Logo are trademarks or registered trademarks of HDMI Licensing LLC in the United States and other countries.