

# Hisense

life reimagined

## USER'S OPERATION MANUAL

Before operating this unit, please read this manual thoroughly, and retain for future reference

**RB335N4WB1**  
**RB335N4WG1**

English

## Contents

Safety and warning information _____	2	Helpful hints and tips _____	16
Installing your new appliance _____	8	Cleaning and care _____	18
Description of the appliance _____	13	Troubleshooting _____	20
Control panel _____	14	Disposal of the appliance _____	22
Using your appliance _____	16		



This appliance is in accordance with the following EU guidelines: LVD 2014/35/EU and EMC 2014/30/EU and 2009/125/EC and EC.643/2009 and 2002/96/EC



## Safety and warning information

For your safety and correct usage, before installing and first using the appliance, read this user manual carefully, including its hints and warnings.

To avoid unnecessary mistakes and accidents, it is important to make sure that all people using the appliance are thoroughly familiar with its operation and safety features. Save these instructions and be sure that they remain with the appliance if it is moved or sold, so that anyone, using it throughout its life, will be properly informed on usage and safety notices. For the safety of life and property, keep the precautions of these user's instructions as the manufacturer is not

responsible for damages caused by omission.

### **Safety for children and others who are vulnerable people**

- This appliance can be used by children aged from 8 years and above and persons with reduced physical, sensory or mental capabilities or lack of experience and knowledge if they have been given supervision or instruction concerning use of the appliance in a safe way and understand the hazards involved. Children shall not play with the appliance. Cleaning and user maintenance shall not be made by children without supervision.
- Keep all packaging away from children as there is risk of suffocation.

- If you are discarding the appliance, pull the plug out of the socket, cut the connection cable (as close to the appliance as you can) and remove the door to prevent children playing from suffering an electric shock or from closing themselves inside it.
- If this appliance, featuring a magnetic door seals, is to replace an older appliance having a spring lock (latch) on the door or lid, be sure to make the spring lock unusable before you discard the old appliance. This will prevent it from becoming a death trap for a child.

### General safety



• **WARNING** - This appliance is intended to be used in household and similar applications such as

- staff kitchen areas in shops, offices and other working environments;
- farm houses and by clients in hotels, motels and other residential type environments;
- bed and breakfast type environments;

- catering and similar non-retail applications
- **WARNING** - Do not store explosive substances such as aerosol cans with a flammable propellant in this appliance.
- **WARNING** - If the supply cord is damaged, it must be replaced by the manufacturer, its service agent or similarly qualified persons in order to avoid a hazard.
- **WARNING** - Keep ventilation openings, in the appliance enclosure or in the built-in structure, clear of obstruction.
- **WARNING** - Do not use mechanical devices or other means to accelerate the defrosting process, other than those recommended by the manufacturer.
- **WARNING** - Do not damage the refrigerant circuit.
- **WARNING** - Do not use electrical appliances inside the food storage compartments of the appliance, unless they are of the type recommended by the manufacturer.
- **WARNING** - The refrigerant and insulation

blowing gas are flammable.

When disposing of the appliance, do so only at an authorized waste disposal centre. Do not expose to flame.

### Refrigerant

The refrigerant isobutene (R600a) is contained within the refrigerant circuit of the appliance, a natural gas with a high level of environmental compatibility, which is nevertheless flammable. During transportation and installation of the appliance, ensure that none of the components of the refrigerant circuit becomes damaged. The refrigerant (R600a) is flammable.



#### **Caution: risk of fire**

If the refrigerant circuit should be damaged:

- Avoid opening flames and sources of ignition.
  - Thoroughly ventilate the room in which the appliance is situated.
- It is dangerous to alter the specifications or modify this product in any way.

Any damage to the cord may cause a shortcircuit, fire, and/or electric shock.



#### **Electrical safety**

1. The power cord must not be lengthened.
2. Make sure that the power plug is not crushed or damaged. A crushed or damaged power plug may overheat and cause a fire.
3. Make sure that you can access the main plug of the appliance.
4. Do not pull the main cable.
5. If the power plug socket is loose, do not insert the power plug. There is a risk of electric shock or fire.
6. You must not operate the appliance without the interior lighting lamp cover.
7. The fridge is only applied with power supply of single phase alternating current of 220~240V/50Hz. If fluctuation of voltage in the district of user is so large that the voltage exceeds the above scope, for safety sake, be

sure to apply A.C. Automatic voltage regulator of more than 350W to the fridge. The fridge must employ a special power socket instead of common one with other electric appliances. Its plug must match the socket with ground wire.

### **Daily use**

- Do not store flammable gass or liquids in the appliance, There is a risk of an explosion.
- Do not operate any electrical appliances in the appliance(e.g.electric ice cream makers,mixers etc.).
- When unplugging always pull the plug from the mains socket,do not pull on the cable.
- Do not place hot items near the plastic components of this appliance.
- Do not place food products directly against the air outlet on the rear wall.
- Store pre-packed frozen food in accordance with the frozen food manufacture's instructions.
- The appliances manufactures storage recommendations should be strictly adhered to.Refer to relevant instructions for storage.
- Do not place carbonated or fizzy drinks in the freeze compartment as it creates pressure on the container, which may cause it to explode, resulting in damage to the appliance.
- Frozen food can cause frost burns if consumed straight from the freezer compartment.
- Do not place the appliance in direct sunlight.
- Keep burning candles, lamps and other items with naked flames away from the appliance so that do not set the appliance on fire.
- The appliance is intended for keeping food stuff and/or beverages in normal household as explained in this instruction booklet The appliance is heavy.Care should be taken when moving it.
- Do not remove or touch items from the freezer compartment if your

---

hands are damp/wet, as this could cause skin abrasions or frost/freezer burns.

- Never use the base, drawers, doors etc. to stand on or as supports.
- Frozen food must not be refrozen once it has been thawed out.
- Do not consume ice popsicles or ice cubes straight from the freezer as this can cause freezer burn to the mouth and lips.
- To avoid items falling and causing injury or damage to the appliance, do not overload the door racks or put too much food in the crisper drawers.

### **caution!**

#### **Care and cleaning**

- Before maintenance, switch off the appliance and disconnect the mains plug from the mains socket.
- Do not clean the appliance with metal objects, steam cleaner, ethereal oils, organic solvents or abrasive cleansers.
- Do not use sharp objects to remove frost from the

appliance. Use a plastic scraper.

### **Installation Important!**

- For electrical connection carefully, follow the instructions given in this manual.
- Unpack the appliance and check if there are damages on it. Do not connect the appliance if it is damaged. Report possible damages immediately to the place you bought it. In this case retain packing.
- It is advisable to wait at least four hours before connecting the appliance to allow the oil to flow back in the compressor.
- Adequate air circulation should be around the appliance, lacking this leads to overheating. To achieve sufficient ventilation, follow the instructions relevant to installation.
- Wherever possible the back of the product should not be close to a wall to avoid touching or catching warm parts (compressor, condenser) to prevent the risk of a fire, follow the instructions

relevant to installation.

- The appliance must not be located close to radiators or cookers.
- Make sure that the mains plug is accessible after the installation of the appliance.

### **Service**

Any electrical work required to do the servicing of the appliance should be carried out by a qualified electrician or competent person.

This product must be serviced by an authorized Service Center, and only genuine spare parts must be used.

- 1) If the appliance is Frost Free.
- 2) If the appliance contains a freezer compartment.

## Installing your new appliance

Before using the appliance for the first time, you should review the following tips.

### Ventilation of appliance

 In order to improve efficiency of the cooling system and save energy, it is necessary to maintain good ventilation around the appliance. For this reason, sufficient clear space should be available around the refrigerator.

It is advisable for there to be at least 75mm of space from the back to the wall, at least 100mm from its top, at least 100mm from its side to the wall and a clear space in front to allow the doors to open 130°. Please see the following diagrams.

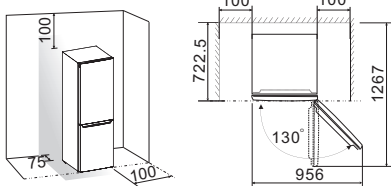

Note:

- This appliance performs well within the climate class from SN to T showed in the table below.

It may not work properly if left at a temperature above or below the indicated range for a long period.

Climate class	Ambient temperature
SN	+10°C to +32°C
N	+16°C to +32°C
ST	+16°C to +38°C
T	+16°C to +43°C

- Stand your appliance in a dry place to avoid moisture damage.
- Keep the appliance out of direct sunlight, rain or frost. Stand the appliance away from heat sources such as stoves, fires or heaters.

Leveling of appliance

- For sufficient leveling and air circulating in the lower rear section of the appliance, the bottom feet may need to be adjusted. You can adjust them manually using a suitable spanner.



- To allow the doors to self-close, tilt the top backwards by about 10mm.

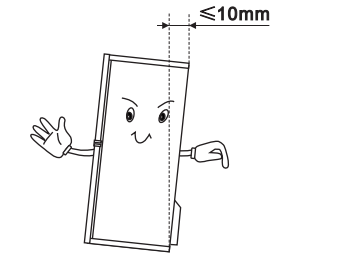





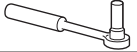

### Reversing the door

The side at which the door opens can be changed, from the right side (as supplied) to the left side, if required.

**Warning!** When reversing the door, the appliance must not be connected to the mains. Ensure that the plug is removed from the mains socket.

### Tools you will need

Not provided		
		
8mm socket wrench	Cross-shaped screwdriver	
		
Thin-blade screwdriver	Monkey wrench	8mm wrench
Additional parts (in the plastic bag)		
		
left door stopper	Left Hinge Cover	

Note: If required you may lay the refrigerator on its back in order to gain access to the base, you should rest it on soft foam packaging or similar material to avoid damaging the backboard of the refrigerator. To reverse the door, the following steps are generally recommended.

1. Stand the refrigerator upright. Open the upper door to take out all door racks (to avoid damage) and then close the door.

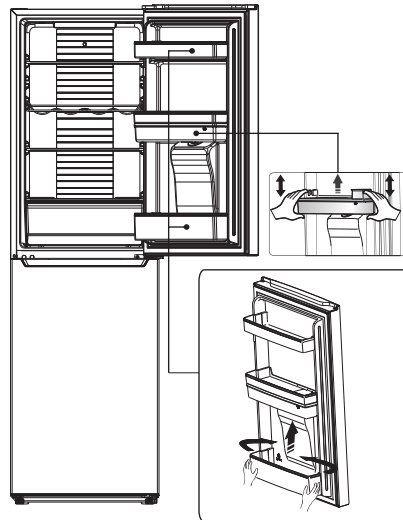

**Caution!** Please slightly squeeze the door rack from two sides toward centre and inside of door rack, and then move it upward when taking out the upper rack and lower rack.

2. Remove right upper hinge cover ① on top of the cabinet. remove the 3 screws ② which are used for fixing the right upper hinge part (see the picture below) and take down the upper hinge parts ③

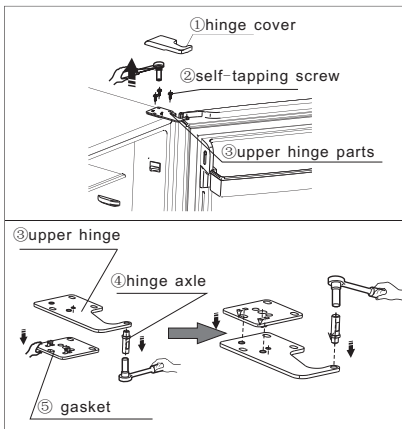

3. Loosen the hinge axle ④ with monkey wrench and change it to the reverse hole site, and then tighten into position. Take down the gasket ⑤ and change it to the reverse hole site.

**Caution!** Please hold the upper door in place during step 3 to prevent the door dropping.

4. Remove screw cover from the left-front corner of cabinet with thin-blade screwdriver and install it to the right-front corner.

5. Remove the upper door from the middle hinge by carefully lifting the door straight up.

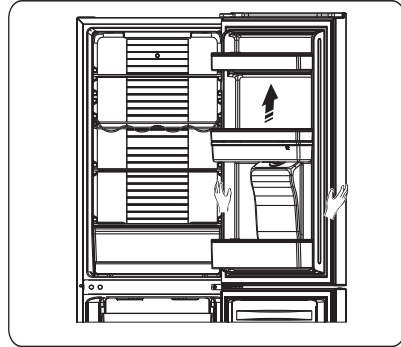

6. Place the upper door on a smooth surface with its panel upwards. Loose screw ③ and take down part ② and part ①, Install replacement door stopper-left ④ provided (in the plastic bag) and part ② (stop block) to the left side with screw ③. Keep part ① with the appliance for future reference.

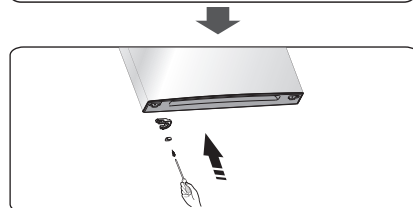
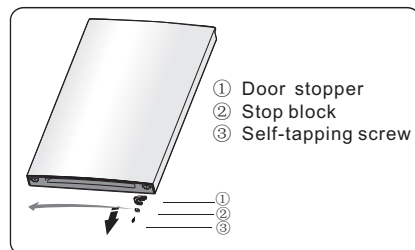

7. Loosen screws used to fix the middle hinge and remove middle hinge. Then remove the lower door.

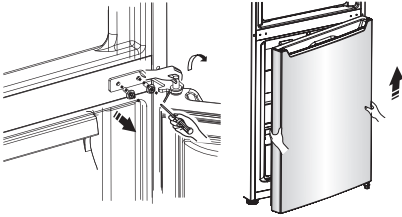

8. Place the lower door on a smooth surface with its panel upwards. Loosen screw ③ and take down part ② and part ①. Install replacement door stopper-left ④ provided (in the plastic bag) and part ② (stop block) to the left side with screw ③. Keep part ① with the appliance for future reference.

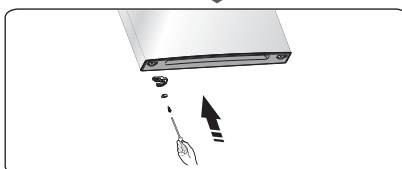
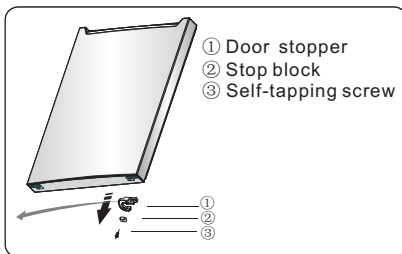

9. Change screw hole covers and screw on middle cover plate from left to right (as shown in figure below).

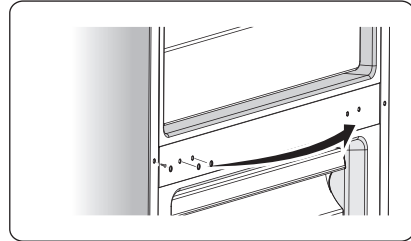

10. Tip the refrigerator backwards, remove part ③ and then remove screws ④.

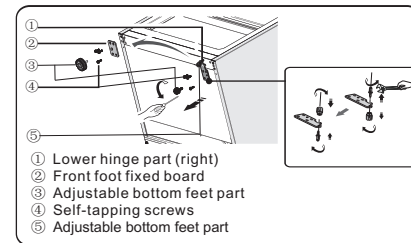

11. Remove part ⑤ from the lower hinge pin, loose out the lower hinge pin, change it to the reverse hole site, and then tighten into position, then install part ⑤ on the lower hinge pin.

12. Remove part ③ from the part ②, then remove screws ④, screw part ③ to the reverse hole site.

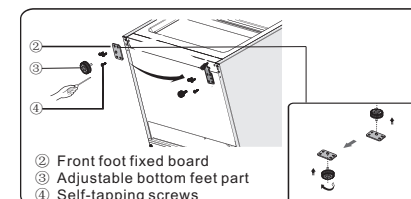

13. Replace the items remount in step 11 and step 12, change part ① to left and part ② to right and then fix them with screws ④. Finally install part ③.

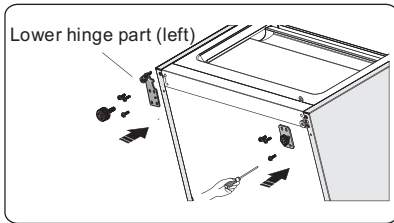

14. Stand the refrigerator upright and carefully slot the lower door onto the bottom hinge pin and hold in position. Turn the middle hinge by 180°, change the washer on the axis to the lower side, adjust the middle hinge to the appropriate position and then install it ensuring the lower door is secured in place.

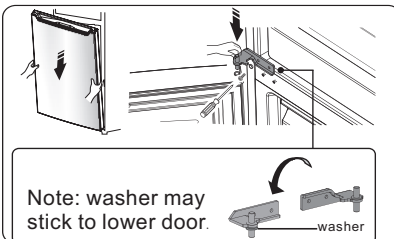

15. Carefully slot the upper door onto the middle hinge pin and hold in position. Move the upper door to an appropriate position, adjust upper hinge and upper

door, then fit the hinge pin into the hinge hole at the top or the door to secure the door in place. Then fix the upper hinge part with screws.

(Please carefully hold upper door by hand when installing)

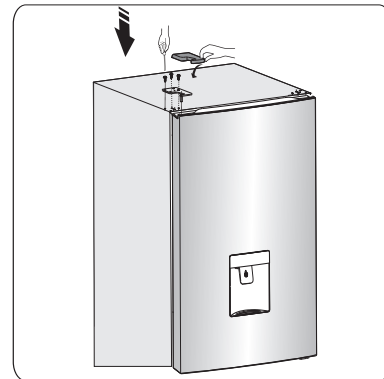
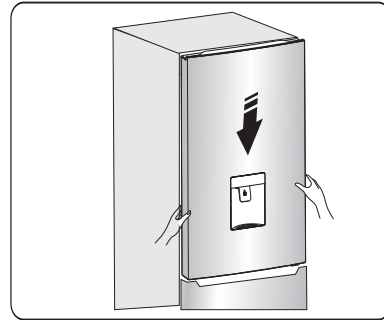

16. Assemble the hinge cover-left provided (in the plastic bag) to match the hinge, install the door racks and water tank to original position. Keep the hinge cover-right with the appliance for future reference.

## Description of the appliance

1. Upper hinge cover
2. Control panel part
3. Glass shelf
4. Bottle rack
5. Crisper drawer cover
6. Fruit and vegetables crisper
7. Freezer tray
8. Ice tray(inside)
9. Upper glass shelf
10. Upper freezer drawer
11. Middle freezer drawer
12. Lower freezer glass shelf
13. Lower freezer drawer
14. Adjustable bottom feet
15. Fridge door
16. Upper rack
17. Egg tray (inside)
18. Middle rack
19. Water tank
20. Fridge door seal
21. Lower rack
22. Freezer door seal
23. Freezer door

View 1 of the appliance

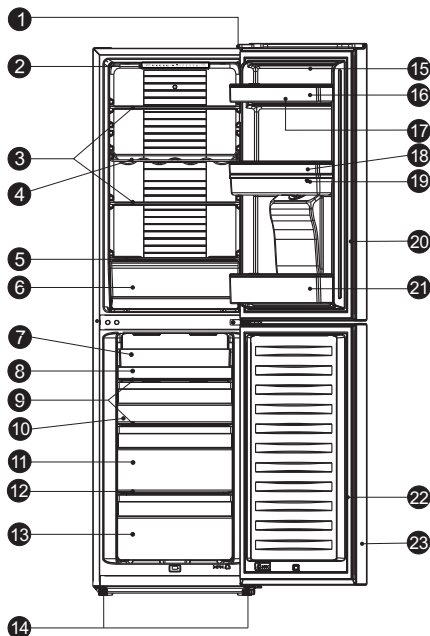

**Note:** Due to constant development of our products, your refrigerator may be slightly different with this instruction manual, but its functions and usage remain the same. To get more space in freezer, you can remove drawers (except the bottom freezer drawer), ice tray.

## Control panel

Use your appliance according to the following guidelines, your appliance has functions as the control panel shown in the pictures below.

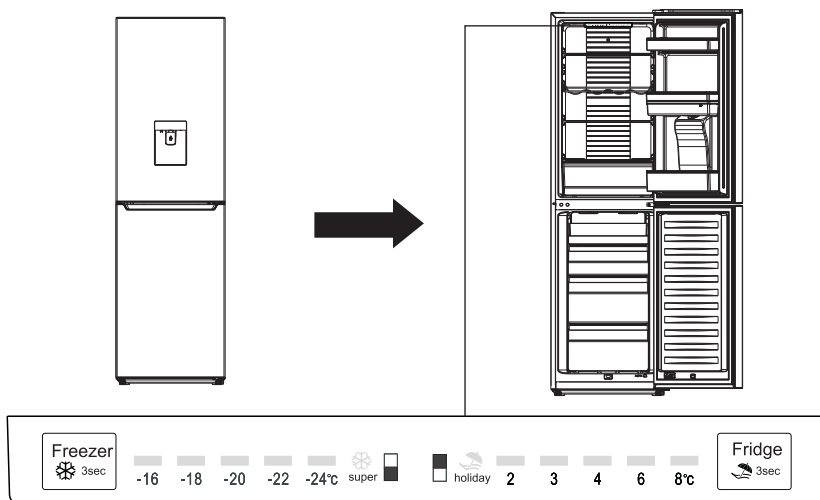

### Controlling the temperature

We recommend that when you start your refrigerator for the first time, the temperature for the refrigerator is set to 4°C and the freezer to -18°C. If you want to change the temperature, follow the instructions below.

**Caution!** When you set a temperature, you set an average temperature for the whole refrigerator cabinet. Temperatures inside each compartment may vary from the temperature displayed on the panel,

depending on how much food you store and where you place them. Ambient temperature may also affect the actual temperature inside the appliance.

### 1. Fridge

Press the middle part of  button to set fridge temperature between 2°C and 8°C as needed, and control panel will display corresponding figures according to the following sequence.

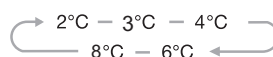

## 2. Freezer

Press the middle part of  button to set fridge temperature between  $-16^{\circ}\text{C}$  and  $-24^{\circ}\text{C}$  as needed, and control panel will display corresponding figures according to the following sequence.

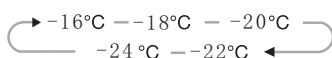



## 3. Super Freeze



Super Freeze will quickly lower the temperature within

the freezer so food will freeze faster. This can lock in nutrients of food and keep food fresh for longer.

- Press the middle part of  button for 3 seconds to activate the super freeze function. The light  will be on.
- Super freezer will automatically switch off after 26 hours.
  - When super freeze function is on, you can switch off super freeze function by

pressing the middle part of  button and the freezer temperature setting will revert back to the previous setting.

## 4. Holiday



If you are going to be away for a long period of time, you

can activate this function by pressing the middle part of



button for 3 seconds until the light  comes on.

- When the holiday function is activated, the temperature of the refrigerator will be automatically switched to  $15^{\circ}\text{C}$  to minimize the energy consumption. Important! Do not store any food in the fridge during this time.
- When holiday function is on, you can switch it off by pressing the middle part of  button. The fridge temperature setting will revert back to the previous setting.

## Using your appliance

Your appliance has the accessories as the “Description of the appliance” showed in general, with this part instruction you can have the right way to use them.

### • Door rack

It is suitable for the storage of eggs, canned liquid, bottled drinks and packed food, etc. Do not place too many heavy things in the racks.

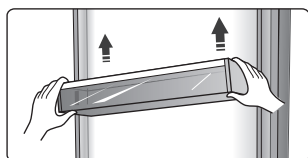

### Shelf in Refrigerator chamber

- There are shelves in refrigerator chamber, and they can be taken out to be cleaned.

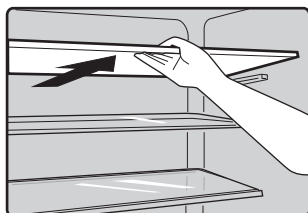

### Bottle rack

- It is for storing bottled wine or drinks, and it can be taken out to be cleaned.

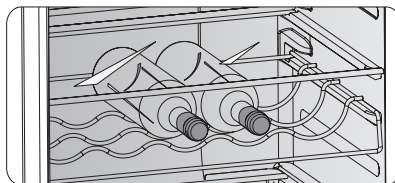

### Water Dispenser

The water dispenser, located in the fridge door, is for storing drinking water. With this appliance you can obtain chilled water easily without opening the refrigerator. You should be informed of following tips.

- Before using
  1. Take out the middle rack.
  2. Hold the two sides of the water tank tightly, then pull up the water tank by shaking up and down.
  3. Unscrew the head, then clean it and the inside of water tank.

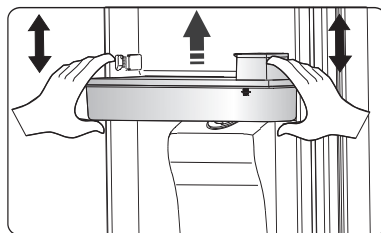



## ● Assembling

Before assembling, please drain the water inside the tank, and check whether the washer reversed or not.

1. Insert the head into the hole.
2. Fit the tank along the guides on the door.
3. Press down two side of the tank.
4. When you hear a click sound, that means the installation is completed.

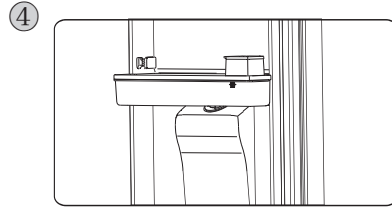
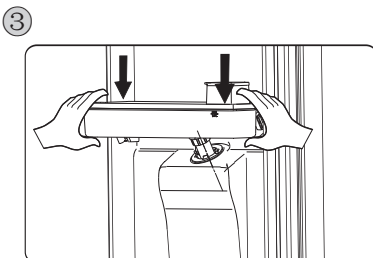
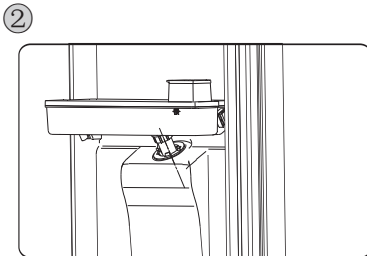
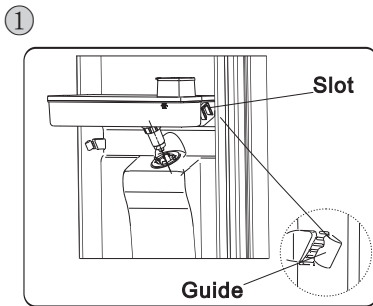

## Warning!

1. Be careful not to press on the head;
2. When fitting the water tank, ensure the head inserted into the hole first;
3. If you found the washer reversed or loosed when removing the tank, you must take off the fixed holder by contrarotating it first, then put the washer to the correct position, and install the fixed holder at last.

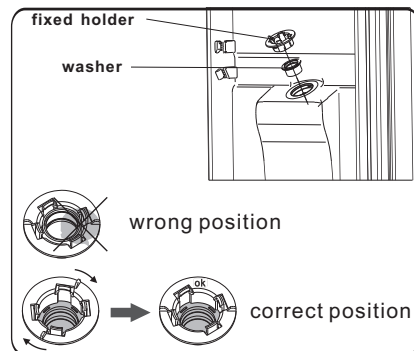

## ● Filling water

Before you fill the drinking water into the water tank, ensure that the water tank is steady and in a correct position.

**Caution!**

Fill with water up to 2.1L (which is suggested), and not above the level. Otherwise, it may overflow when the lid is close.

We recommend that you fill the water by the following way.

Open the small lid by rotating it, and fill water from the inlet of the large lid. Please remember rotate the small lid back to it's original position when finish filling water.

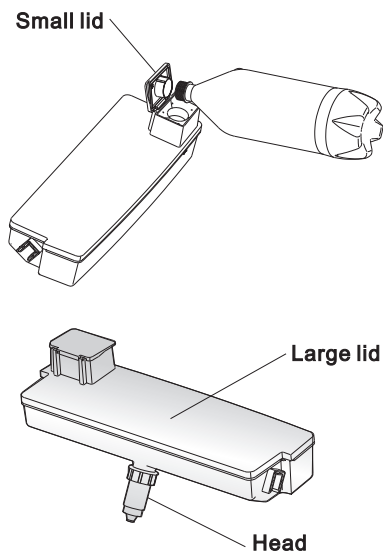
**Warning!**

Don't touch other parts of the appliance when filling water, it may cause the water leakage.

**● Dispensing water**

1. Make sure the cover of the water tank is fitted on.
2. Close the fridge door and check the dispenser.

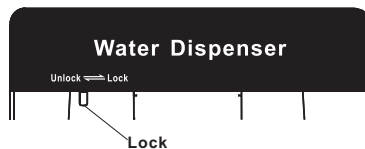

Before you dispense the water, make sure the lock device is on "UNLOCK" situation.

**Warning!**

The lock is defined as "child lock".

Don't push the dispenser lever forward strongly, when the dispenser is on "LOCK" situation, it may damage the mechanism.

**● Receiving Water**

You should use the correct cups to receive water underneath the water dispenser.

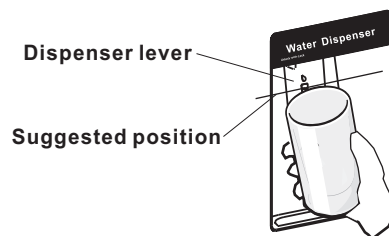

**Warning!**

Don't push the dispenser lever forward without cup, it may cause the water leak from the dispenser.

**● Cleaning**

1. Put the water tank out of the door carefully, and then wash the tank, lid, and head lightly in water.
2. After you have successfully cleaned the appliance, you should dry it by natural drying or using the dryer.

3. If you have used the water dispenser for many times, the water in the receiving tank may drop on the floor, which may make your floor wet, and you should clean the tank with dry towel regularly before overflow.

**Helpful hints and tips****Energy saving tips**

We recommend that you follow the tips below to save energy.

- Try to avoid keeping the door open for long periods in order to conserve energy.
- Ensure the appliance is away from any sources of heat (Direct sunlight, electric oven or cooker etc).
- Don't set the temperature colder than necessary.

- Don't store warm food or evaporating liquid in the appliance.
- Place the appliance in a well ventilated, humidity free, room. Please refer to Installing your new appliance chapter.
- If the diagram shows the correct combination for the drawers, crisper and shelves, do not adjust the combination as this is designed to be the most

---

### **Hints for fresh food refrigeration**

- Do not place hot food directly into the refrigerator or freezer, the internal temperature will increase resulting in the compressor having to work harder.
- Cover or wrap food, particularly if it has a strong flavor.
- Place food carefully so that air can circulate freely around it.

#### Hints for refrigeration

- Meat (All Types) Wrap in polythene food: wrap and place on the glass shelf above the vegetable drawer. Always follow food storage times and use by dates suggested by manufacturers.
- Cooked food, cold dishes, etc.: They should be covered and may be placed on any shelf.
- Fruit and vegetables: They should be stored in the special drawer provided.
- Butter and cheese: Should be wrapped in airtight foil or plastic film wrap.

#### •Milk bottles:

Should have a lid and be stored in the door racks.

### **Hints for freezing**

- When first starting-up or after a period out of use, let the appliance run at least 2 hours on the higher settings before putting food in the compartment.
- Prepare food in small portions to enable it to be rapidly and completely frozen and to make it possible to subsequently thaw only the quantity required.
- Wrap up the food in aluminum foil or polyethylene food wraps which are airtight.
- Do not allow fresh, unfrozen food to touch the food which is already frozen to avoid temperature rise of the latter.
- Iced products, if consumed immediately after removal from the freezer compartment, will probably cause frost burns to the skin.
- It is recommended to label and date each frozen package in order to keep track of the storage time.

### Hints for the storage of frozen food

- Ensure that frozen food has been stored correctly by the food retailer.
- Once defrosted, food will deteriorate rapidly and should not be re-frozen. Do not exceed the storage period indicated by the food manufacturer.

### Switching off your appliance

If the appliance needs to be switched off for an extended period, the following steps should be taken prevent mould on the appliance.

1. Remove all food.
2. Remove the power plug from the mains socket.
3. Clean and dry the interior thoroughly.
4. Ensure that all the doors are wedged open slightly to allow air to circulate.

## Cleaning and care

For hygienic reasons the appliance (including exterior and interior accessories) should be cleaned regularly (at least every two months).

**Caution!** The appliance must not be connected to the mains during cleaning as there is a danger of electrical shock!

### Exterior cleaning

-Wipe the control panel with a clean, soft cloth.

-Spray water onto the cleaning cloth instead of spraying directly on the surface of the appliance. This helps ensure an even

distribution of moisture to the surface.

-Clean the doors, handles and cabinet surfaces with a mild detergent and then wiped dry with a soft cloth.

**Caution!**

-Don't use sharp objects as they are likely to scratch the surface.

-Don't use Thinner, Car detergent, Clorox, ethereal oil, abrasive cleansers or organic solvent such as Benzene for cleaning. They may damage the surface of the appliance and may cause fire.

### Interior cleaning

You should clean the appliance interior regularly. Wipe the inside of the fridge freezer with a weak solution of bicarbonate of soda, and then rinse with warm water using a wrung-out sponge or cloth. Wipe completely dry before replacing the shelves and baskets.

Thoroughly dry all surfaces and removable parts.

Although this appliance automatically defrosts, a layer of frost may occur on the freezer compartment's interior frequently or kept open too long. If the frost is too thick, choose a time when the supply of food stocks are low and proceed as follows:

1. Remove existing food and accessories baskets, unplug the appliance from the mains power and leave the doors open. Ventilate the room thoroughly to accelerate the thawing process.
2. When defrosting is completed, clean your freezer as described above.

**Caution!** Don't use sharp objects to remove frost from the freezer compartment. Only after the interior is completely dry should the appliance be switched back on and plugged back into the mains socket.

### Door seals cleaning

Take care to keep door seals clean. Sticky food and drinks can cause seals to stick to the cabinet and tear when you open the door. Wash seal with a mild detergent and warm water. Rinse and dry it thoroughly after cleaning.

**Caution!** Only after the door seals are completely dry should the appliance be powered on.

**Replacing the LED light:**

Warning: The LED light should be replaced by a competent person. If the LED light is damaged, contact the customer helpline for assistance. To replace the LED light, the below steps can be followed:

1. Unplug your appliance.
2. Remove light cover by pushing up and out.
3. Hold the LED cover with one hand and pull it with the other hand while pressing the connector latch.
4. Replace LED light and snap it correctly in place.

### Troubleshooting

If you experience a problem with your appliance or are concerned that the appliance is not functioning correctly, you can carry out some easy checks before calling for service, please see below.

**Warning!** Don't try to repair the appliance yourself. If the problem persists after you have made the checks mentioned below, contact a qualified electrician, authorized service engineer or the shop where you purchased the product.

Problem	Possible cause & Solution
Appliance is not working correctly	Check whether the power cord is plugged into the power outlet properly.
	Check whether the "Power" function is on by pressing the "power" button for 1 second.
	Check the fuse or circuit of your power supply, replace if necessary.
	The ambient temperature is too low. Try setting the chamber temperature to a colder level to solve this problem.

Appliance is not working correctly	It is normal that the refrigerator is not operating during the automatic defrost cycle, or for a short time after the appliance is switched on to protect the compressor.
Odours from the compartments	The interior may need to be cleaned.
	Some food, containers or wrapping cause odours.
Noise from the appliance	<p>The sounds below are quite normal:</p> <ul style="list-style-type: none"> <li>• Compressor running noises.</li> <li>• Air movement noise from the small fan motor in the fridge compartment or other compartments.</li> <li>• Gurgling sound similar to water boiling.</li> <li>• Popping noise during automatic defrosting.</li> <li>• Clicking noise before the compressor starts.</li> </ul>
	<p>Other unusual noises are due to the reasons below and may need you to check and take action:</p> <ul style="list-style-type: none"> <li>• The cabinet is not level.</li> <li>• The back of appliance touches the wall.</li> <li>• Bottles or containers fallen or rolling.</li> </ul>
The motor runs continuously	<p>It is normal to frequently hear the sound of the motor, it will need to run more when in following circumstances:</p> <ul style="list-style-type: none"> <li>• Temperature setting is set colder than necessary</li> <li>• Large quantity of warm food has recently been stored within the appliance.</li> <li>• The temperature outside the appliance is too high.</li> <li>• Doors are kept open too long or too often.</li> </ul>



The motor runs continuously	<ul style="list-style-type: none"> <li>• After your installing the appliance or it has been switched off for a long time.</li> </ul>
A layer of frost occurs in the compartment	Check that the air outlets are not blocked by food and ensure food is placed within the appliance to allow sufficient ventilation. Ensure that door is fully closed. To remove the frost, please refer to cleaning and care chapter.
Temperature inside is too warm	You may have left the doors open too long or too frequently; or the doors are kept open by some obstacle; or the appliance is located with insufficient clearance at the sides, back and top.

### Disposal of the appliance

It is prohibited to dispose of this appliance as household waste.

#### **Packaging materials**

Packaging materials with the recycle symbol are recyclable. Dispose of the packaging into a suitable waste collection container to recycle it.

#### **Before disposal of the appliance**

1. Pull out the mains plug from the mains socket.
2. Cut off the power cord and discard with the mains plug.

Warning! Refrigerators contain refrigerant and gases in the insulation. Refrigerant and gases must be disposed of professionally as they may cause eye injuries or ignition. Ensure that tubing of the refrigerant circuit is not damage prior to proper disposal.

	Correct Disposal of this product
	<p>This marking indicates that this product should not be disposed with other household wastes throughout the EU. To prevent possible harm to the environment or human health from uncontrolled waste disposal, recycle it responsibly to promote the sustainable reuse of material resources. To return your used device, please use the return and collection systems or contact the retailer where the product was purchased. They can take this product for environmental safe recycling.</p>

**Hisense Service Help Line: 0844 3460087**

**Hisense**  
life reimagined

Hisense UK Ltd  
Unit 2 Meadow Court  
Millshaw Lane  
Leeds  
LS11 8LZ