

Hisense

life reimagined

USER'S OPERATION MANUAL

Before operating this unit, please read this manual thoroughly, and retain for future reference

RS723N4WC1
RS723N4WB1

English

Contents

Safety and warning information.....2	Using your appliance.....12
Installing your new appliance7	Helpful hints and tips.....15
Description of the appliance.....9	Cleaning and care.....16
Display controls.....10	Troubleshooting.17
	Disposal of the appliance.....19

CE This appliance is produced in accordance with the following EU guidelines: 2014/35/EU, 2014/30/EU, 2009/125/EC, EC.643/2009 and 2002/96/EC.



Safety and warning information Contents

For your safety and correct usage, before installing and first using the appliance, read this user manual carefully, including its hints and warnings.

To avoid unnecessary mistakes and accidents, it is important to make sure that all people using the appliance are thoroughly familiar with its operation and safety features. Save these instructions and be sure that they remain with the appliance if it is moved or sold, so that anyone using it throughout its life will be properly informed on usage and safety notices.

For the safety of life and property, keep the precautions of these user's instructions as the manufacturer is not responsible for damages

caused by omission.

Safety for children and others who are vulnerable

- This appliance can be used by children aged from 8 years and above, and persons with reduced physical, sensory or mental capabilities or lack of experience and knowledge if they have been given supervision or instruction concerning use of the appliance in a safe way and understand the hazards involved. Children shall not play with the appliance. Cleaning and user maintenance should not be carried out by children without supervision.
- Keep all packaging away from children as there is risk of suffocation.

- If you are discarding the appliance, pull the plug out of the socket, cut the connection cable (as close to the appliance as you can) and remove the door to prevent children from suffering an electric shock or from closing themselves inside.
- If this appliance, featuring a magnetic door seals, is to replace an older appliance having a spring lock (latch) on the door or lid, please make the spring lock unusable before you discard the old appliance. This will reduce the risk of trapping children or animals inside.

General safety



- **WARNING** — This appliance is designed to be used in domestic households and not intended for use in retail or commercial environments.

- **WARNING** — Do not store explosive substances such as aerosol cans with a flammable propellant in this appliance.
- **WARNING** — If the supply cord is damaged, it must be replaced by the manufacturer, its service agent or similarly qualified persons in order to avoid a hazard.
- **WARNING** — Keep ventilation openings in the appliance enclosure or in any built-in structure clear of obstruction.
- **WARNING** — Do not use mechanical devices or other means to accelerate the defrosting process, other than those recommended by the manufacturer.
- **WARNING** — Do not damage the refrigerant circuit.
- **WARNING** — Do not use electrical appliances inside the food storage compartments of the appliance, unless they are of the type recommended by the manufacturer.
- **WARNING** — The refrigerant and insulation are flammable.

When disposing of the appliance, do so only at an authorized waste disposal center. Do not expose to flame.

Refrigerant

The refrigerant isobutene (R600a) is contained within the refrigerant circuit of the appliance. This is a natural gas with a high level of environmental compatibility, which is nevertheless flammable. During transportation and installation of the appliance, ensure that none of the components of the refrigerant circuit becomes damaged.

The refrigerant (R600a) is flammable.



Caution: risk of fire

If the refrigerant circuit is damaged:

- Avoid naked flames and sources of ignition.
- Thoroughly ventilate the room in which the appliance is situated.

It is dangerous to alter the specifications or modify this product in any way.

Any damage to the cord may cause a shortcircuit,

fire, and/or electric shock.



Electrical safety

- 1.The power cord must not be lengthened.
- 2.Make sure that the power plug is not crushed or damaged. A crushed or damaged power plug may overheat and cause a fire.
- 3.Make sure that you can access the main plug of the appliance.
- 4.Do not pull the main cable.
- 5.If the power plug socket is loose, do not insert the power plug. There is a risk of electric shock or fire.
- 6.You must not operate the appliance without the interior lighting lamp cover.
- 7.The fridge should only be supplied with single phase alternating current of 220 ~ 240V / 50Hz . If the supply fluctuates outside this range an automatic A.C. voltage regulator of more than 350W should be used. The fridge should be plugged into an adequately earthed supply

Daily use

- Do not store flammable gas or liquids in the appliance, there is a risk of explosion.
- Do not operate any electrical appliances in the appliance (e.g. electric ice cream makers, mixers etc.).
- When unplugging always pull the plug from the mains socket. Do not pull on the cable.
- Do not place hot items near the plastic components of this appliance.
- Do not place food products directly against the air outlet on the rear wall.
- Store pre-packed frozen food in accordance with the frozen food manufacture's instructions.
- The manufacturer's storage recommendations should be strictly adhered to. Refer to relevant instructions for storage.
- Do not place carbonated or fizzy drinks in the freezer compartment as it creates pressure on the container, which may cause it to explode, resulting in damage to the appliance.
- Frozen food can cause frost burns if consumed straight from the freezer compartment.
- Do not place the appliance in direct sunlight.
- Keep burning candles, lamps and other items with naked flames away from the appliance
- The appliance is only intended for keeping food and/or beverages for normal household consumption as explained in this instruction booklet
The appliance is heavy. Care should be taken when moving it.
- Do not remove nor touch items from the freezer compartment if your hands are damp/wet, as this could cause skin abrasions or frost/freezer burns.
- Never use the base, drawers, doors etc. to stand on or as supports.
- Frozen food must not be refrozen once it has been thawed out.

- To avoid items falling and causing injury or damage to the appliance, do not overload the door racks or put too much food in the crisper drawers.

Caution!

Care and cleaning

- Before performing maintenance, switch off the appliance and disconnect the mains plug from the mains socket.
- Do not clean the appliance with metal objects, steam cleaners, ethereal oils, organic solvents or abrasive cleansers.
- Do not use sharp objects to remove frost from the appliance. Use a plastic scraper.

Installation Important!

- For electrical connection carefully, follow the instructions given in this manual. Unpack the appliance and check for damage. Do not connect the appliance if it is damaged. Report possible damage immediately to your retailer. In this case, please retain packing.

- It is advisable to wait at least four hours before connecting the appliance to avoid damaging the compressor.
- Adequate air circulation should be provided around the appliance. To achieve sufficient ventilation. Please follow the instructions relevant to installation.
- Wherever possible the back of the product should not be too close to flammable materials as some components are hot in normal operation. The appliance must not be locate close to radiators or cookers.
- Make sure that the mains plug is accessible following installation of the appliance.

Service

- This product must be serviced by an authorized Service Center or Service Agent, and only genuine spare parts must be used

Installing your new appliance

Before using the appliance for the first time, you should consider the following guidance

Ventilation of appliance



In order to improve the efficiency of the cooling system and save energy, it is necessary to maintain good ventilation around the appliance for the dissipation of heat. For this reason, sufficient clear space should be available around the refrigerator.

It is recommended to leave 75mm of space from the back of the unit to the wall, at least 100mm from its top, at least 100mm from its side to the wall and a clear space upfront to allow the doors to open 145°. See in follow diagrams.

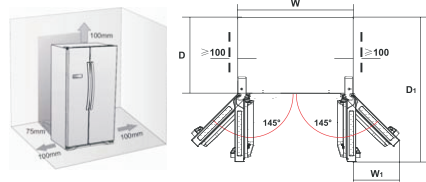

Relevant information (Constant / mm)

W	W1	D	D1
908	387	600	1140

Note!

- This appliance performs well in the below climate class. It may not work properly if being left at a temperature above or below the indicated range for a long period.

Climate class	Ambient temperature
SN	+10°C to +32°C
N	+16°C to +32°C
ST	+16°C to +38°C
T	+16°C to +43°C

- Stand your appliance in a dry place to avoid high moisture.
- Keep the appliance out of direct sunlight, rain or frost. Stand the appliance away from heat sources such as stoves, fires or heaters.

Leveling of appliance

- For sufficient leveling and air circulating in the lower rear section of the appliance, the bottom feet may need to be adjusted. You can adjust them by your fingers or a suitable spanner.

- To allow the doors to self-close, tilt back the top backwards for about 10mm or 0.5° by turning the adjustable feet.

- Whenever you want to move the appliance, remember to turn the feet back up so that the appliance can roll freely. Reinstall the appliance when relocating.

Caution! The rollers, which are not castors, should be only used for forward or backward movement. Moving the refrigerator sideways may damage your floor and the rollers.

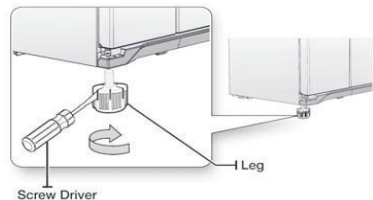
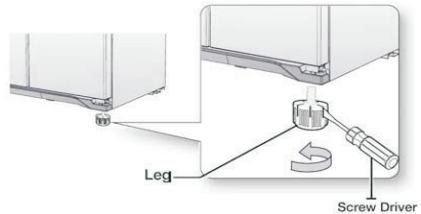

Description of the appliance

View of the appliance



- | | |
|--|-------------------------------------|
| 1. Freezer zone LED light | 11. Fresh zone LED light |
| 2. Wind channel cover in freezer | 12. Wind channel cover in fresh |
| 3. Freezer door Rack (two star zone) | 13. Water tank |
| 4. Freezer shelf | 14. Fresh shelf |
| 5. Temperature regulator (on freezer door) | 15. Wine rack (optional) |
| 6. Movable twist ice-maker (optional) | 16. Fresh door Rack |
| 7. Freezer door gasket | 17. Fruit and vegetables Crisper |
| 8. Freezer drawer | 18. Fresh door gasket |
| 9. Freezer door Rack | 19. Bottles block stripe (optional) |
| 10. Adjustable feet | 20. Bottom cover |

Note: Due to unceasing modification of our products, your refrigerator may be slightly different from this Instruction Manual, but its functions and using methods remain the same.

Display controls

Use your appliance according to the following control guidelines. Your appliance has the corresponding functions and modes as the control panels shown in the pictures below. When the appliance is powered on for the first time, the backlighting of the icons on the display panel starts working. If no buttons have been pressed and the doors are closed, the backlighting will turn off after 60 seconds. The control panel consists of 2 areas showing temperature 7 icons showing mode and and 4 control buttons



Controlling the temperature

We recommend that when you start your refrigerator for the first time, the temperature for the refrigerator is set to 4°C and the freezer to -18°C. If you want to change the temperature, follow the instructions below.

Caution! When you set a temperature, you set an average temperature for the whole refrigerator cabinet. Temperatures inside each compartment may vary from the temperatures displayed on the panel, depending on how much food you store and where you place it. High or low room temperature may also affect the actual temperature inside the appliance.

All the buttons are locked if the icon "🔒" is illuminated, press the "Mode/🔒5s" button for 5 seconds to unlock them.

1. Room

You can activate Fridge OR Freezer compartment temperature setting by pressing "Room" button.

2. Fridge

After fridge temperature setting is activated, press "Temp." button to set "🌡️" fridge temperature between 8°C and 2°C as needed. And the control panel will display corresponding value according to the following sequence.

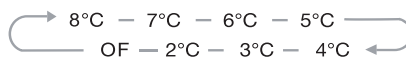

3. Freezer

After freezer temperature setting is activated, press "Temp." button to set "❄️" freezer temperature between -15°C and -25°C as needed. And the control panel will display corresponding value according to the following sequence.

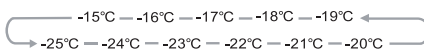

4. Mode/🔒5s

You can select different modes by pressing the "Mode/🔒5s" button. When a certain mode is selected, wait for the corresponding icon flash for 10 seconds. A buzzer will sound two times afterwards and the icon will be illuminated, which means the setting is completed.

5. Super Cool

Super Cool can refrigerate your food much faster, keeping food fresh for a longer period

- Press "❄️" button to activate the super cool function. The corresponding icon will be illuminated.
- When super cool function is on, you can switch off super cool function by pressing "Super Cool" or "Refrigerator" button and the refrigerator temperature setting will revert back to its previous setting.

6. Supper Freeze

Super Freeze will quickly lower the temperature within the freezer so food will freeze faster. This can lock in the vitamins and nutrients of fresh food and keep food fresh longer.

- Press " ❄️ " button to activate the super freeze function. The light will come on.
- When cooling a full freezer of unfrozen food the superfreezer function will take around 24 hours to fully freeze all food items completely.
- Super freeze automatically switches off after 32 hours and the freezer temperature setting displays -25°C.
- When super freeze function is on you can switch off super freeze function by pressing "Super Freeze" or "Freezer" button and the freezer temperature setting will revert back to it's previous setting.

7. Holiday

If you are going to be away for a long period of time, holiday function will be your best choice. you can active this function by pressing " 🏠 " button for 3 seconds until the light will be illuminated.

- When the holiday function is activated, the temperature of the refrigerator is automatically switched to 15°C to minimize the energy consumption.

Important! Do not store any food in the fridge during this time.

- When the holiday function is on, you can switch off it by pressing any button of "Holiday", "Fridge" and "Super Cool" button. The fridge temperature will revert back to it's previous setting.

8. Energy saving

When you are going to be away for a short period the energy saving function

🌡️ is preferable as the refrigerator is automaticall switched to 8°C and the temperature of freezer is automatically switched to -18°C.

9. Artificial intelligence

When the 🧠 function is activated, the temperature of the appliance is automatically adjusted.

Note: If you want to switch off the mode you have selected, simply press the "Room" button and set the temperature of corresponding compartment as you need.

10. Alarm

In case of alarm, " 🔊 " icon will be on and there will be a buzzing sound. Press " 🔊 " key to clear alarm and then "Alarm" icon will turn off and stop the buzzing.

Door Alarm

- If the door of the fridge or freezer is open for over 1 minutes, the door alarm will sound. In case of door alarm, the buzzer will sound 3 times every 1 minute and will automatically stop alarming 10 minutes later.
- To save energy, please avoid keeping the door open for a long time when using the appliance. The door alarm can be cleared by closing the door.

Temperature alarm

- If the freezer temperature is too high due to power failure or other reasons, it will give a temperature alarm and the freezer temperature setting displays "--".
- In case of temperature alarm, the buzzer will sound constantly 10 times.
- In case of temperature alarm, if you want to check the highest freezer temperature, press "Alarm" button for 3 seconds. The temperature value and "Alarm" icon will simultaneously flash for 5 seconds.

Caution! If the appliance has not been used for a while and is switched on, it is normal for the alarm to sound. Please deactivate the alarm by pressing the "Alarm" button.

Using your appliance

This section tells you how to use most of the useful features. We recommend that you read through them carefully before using the appliance.

1. Fixing the bottom cover

Before using your new appliance please fix the bottom plinth using the three self tapping screws provided.



2. Using your refrigerator compartment

The refrigerator compartment is suitable for storing meat, vegetables and fruit. It is recommended that food is packed in sealed containers or wrapped in polythene food wrap to avoid losing moisture or allowing flavours to mix.

Caution! Never close the refrigerator door while the shelves, crisper and/or telescopic slides are extended. It may damage both them and the refrigerator.

Glass shelves and Door racks

The refrigerator compartment is provided with 3 glass shelves and several different door racks, which are suitable for the storage of eggs, canned liquid, bottled drinks and packed food.. They can be placed at different heights according to your needs. Before removing the door shelves, please remove all food items to avoid spillage.

- When you remove the shelves, gently pull them forward until the shelf comes clear of the shelf guides.
- When you return the shelves, make sure there is no obstacle behind and gently push the shelf back into the position.

Crispers

The crisper, mounted on telescopic

extension slides, is for storing vegetables and fruit.

When you remove the crisper pull it forwards and lift off the sliders.

Remember to remove all food first.

Once you have removed the drawers, ensure the slides are pushed back fully.

Bottle holder operation

The bottle holder can be used to hold bottles, cans and tall containers in place. It can be used on the middle and lower door racks and can be moved side to side as required.

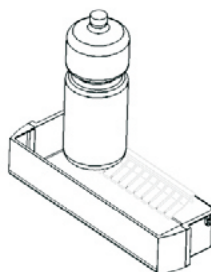

Note: All the door racks and covers are completely removable for cleaning.

3. Using your freezer compartment

The freezer compartment is suitable for storage of foods required to be frozen, such as meat, ice cream and others.

Caution! Ensure that bottles are not left in the freezer for longer than needed as freezing may cause the bottle to break.

Movable twist ice-maker

It is used to make and deposit ice cubes. You should use it as follows.

1. Pull out the twistable ice maker located in the lower freezer drawer.
2. Place the ice maker on level.
3. Pour water into the ice trays and the water line shall not exceed the top line of ice tray.
4. Place the filled ice maker back into the lower freezer.

5. When ice cubes form, take out the ice cube for use directly or twist the knobs clockwise to drop the cubes into ice box for future use.

Note: If the ice tray is used for the first time or has not been used for a long time, please clean it before using. In order to get more space in the freezer, you can remove the ice maker. when not in use.

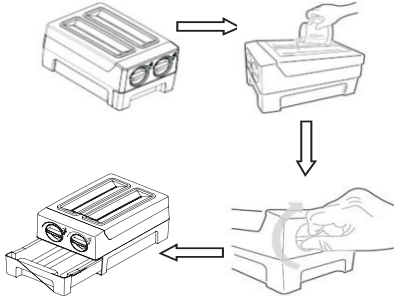

Drawers

The drawers, mounted on telescopic extension slides, can be used to store large quantities of frozen food.

● The method of removal of the drawers is the same as the crisper in the refrigerator chamber.

Water Dispenser

The water dispenser located in the fridge door, is for storing drinking water. With this appliance you can obtain chilled water easily without opening the refrigerator. You should be informed of following tips.

● Before using

Before using this appliance for the first time, you should use it as follows.

1. Hold one bottom side of the water tank by a hand, lift up the opposite side by the other hand, when the slot of the water tank is off from the guide, change hands to repeat these steps.
2. Hold the two sides of the water tank tightly, lift up and put out of the water tank.
3. Unscrew the head, then clean head, lids and the water tank.

Caution!

Drain the water tank before you take it down!

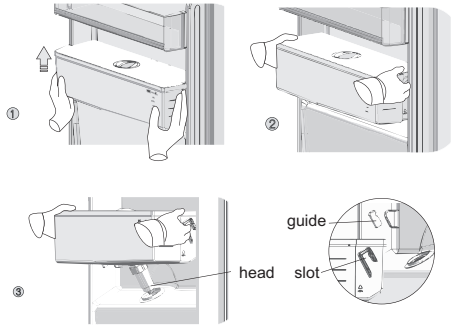

● Assembling

After cleaning, please assemble the parts including the head, water tank and lids as follows:

1. Put the seal ring in order first (the seal ring can not turn up), then insert the head into the hole.
2. Hold the two sides of the water tank tightly, fit the water tank along the guides on the door.
3. Push the two sides of the water tank downward as the picture shows.
4. When you hear clicks by both sides and at the same time the both sides of the water tank is closed to the door liner, It means the installation is completed.

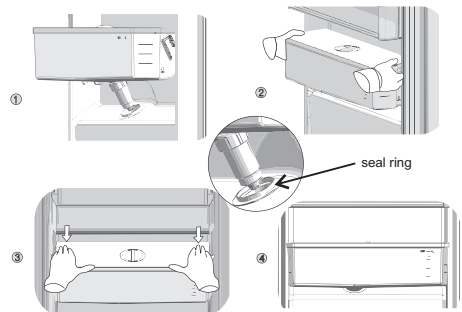

● Filling water

Before you fill the drinking water into the water tank, ensure that the water tank is steady and in a correct position.

Caution!

Fill with water up to 4L (which is suggested) and not above the level. Otherwise, it may overflow when the lids is closed.

We recommend that you fill the water by the following ways.

- 1.Remove the small lid and fill water from the inlet of the larger lid.
- 2.Remove the cover of the tank, and then fill water inside directly.

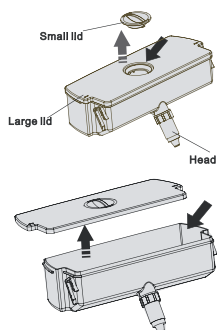
**Warning!**

Don't touch the other parts of the appliance when filling water, it may cause the water leakage.

• Dispensing water

- 1.Make sure the cover of the water tank is fitted on.
- 2.Close the fridge door and check the dispenser.

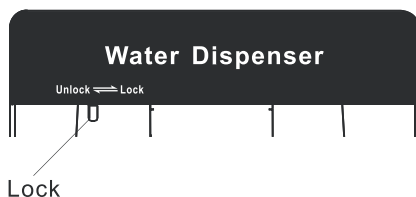

Before you dispense the water, make sure the lock device is on the "Unlock" situation.

Warning!

The lock is defined as "child lock". Don't push the dispenser lever forward strongly, when the dispenser is on "Lock"

situation, it may damage the mechanism.

• Receiving Water

You should use the correct cups to receive water underneath the water dispenser.

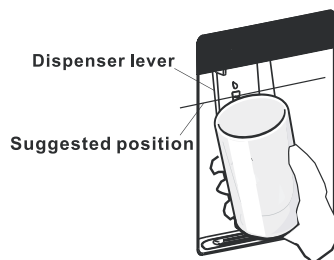
**Warning!**

Don't push the dispenser lever forward without cup, it may cause the water leakage from the dispenser.

Cleaning

- 1.Put the water tank out of the door carefully and then wash the tank, lid, and head lightly in water.
 - 2.After you have successfully cleaned the appliance, you should dry it fully.
- Also regularly clear the receiving tank to avoid spillage .

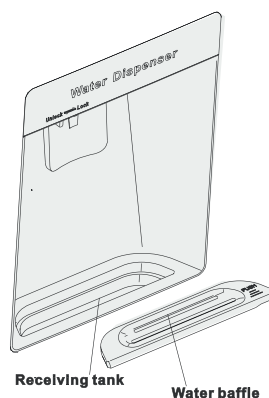

Helpful hints and tips

Energy saving tips

We recommend that you follow the tips below to save energy.

- Try to avoid keeping the door open for long periods in order to conserve energy.
- Ensure the appliance is away from any sources of heat. (Direct sunlight, electric oven or cooker etc.)
- Don't set the temperature colder than necessary.
- Don't store warm food or evaporating liquid in the appliance.
- Place the appliance in a well ventilated, humidity free, room. Please refer to Installing your new appliance chapter.
- The diagram shows the correct combination for the drawers, crisper and shelves. Do not adjust the combination as this is designed to be the most energy efficient configuration.

Hints for fresh food refrigeration

- Do not place hot food directly into the refrigerator, the internal temperature will increase resulting in the compressor having to work harder and will consume more energy.
- Do cover or wrap the food, particularly if it has a strong flavor.
- Place food properly so that air can circulate freely around it.

Hints for refrigeration

- Meat (All Types) Wrap in polythene food: wrap and place on the glass shelf above the vegetable drawer. Always follow food storage times and use by dates suggested by manufacturers.
- Cooked food, cold dishes, etc.: They should be covered and may be placed on any shelf.
- Fruit and vegetables: They should be stored in the special drawer provided.

- Butter and cheese: Should be wrapped in airtight foil or plastic film wrap.

- Milk bottles: Should have a lid and be stored in the door racks.

Hints for freezing

- When first starting-up or after a period out of use, let the appliance run at least 2 hours on the higher settings before putting food in the compartment.
- Prepare food in small portions to enable it to be rapidly and completely frozen and to make it possible to subsequently thaw only the quantity required.
- Wrap up the food in aluminum foil or polyethylene food wraps which are airtight.
- Do not allow fresh, unfrozen food to touch the food which is already frozen to avoid partially thawing the frozen food.
- Iced products, if consumed immediately after removal from the freezer compartment, will probably cause frost burns to the skin.

- It is recommended to label and date each frozen package in order to keep track of the storage time.

Hints for the storage of frozen food

- Ensure that frozen food has been stored correctly by the food retailer.
- Once defrosted, food will deteriorate rapidly and should not be re-frozen. Do not exceed the storage period indicated by the food manufacturer.

Switching off your appliance

If the appliance needs to be switched off for an extended period, the following steps should be taken prevent mould on the appliance.

1. Remove all food.
2. Remove the power plug from the mains socket.
3. Clean and dry the interior thoroughly.
4. Ensure that all the doors are wedged open slightly to allow air to circulate.

Cleaning and care

For hygienic reasons the appliance (including exterior and interior accessories) should be cleaned regularly at least every two months.

Caution! The appliance must not be connected to the mains during cleaning. Danger of electrical shock! Before cleaning switch the appliance off and remove the plug from the mains socket.

Exterior cleaning

To maintain good appearance of your appliance, you should clean it regularly.

-Wipe the digital panel and display panel with a clean, soft cloth.

-Spray water onto the cleaning cloth instead of spraying directly on the surface of the appliance. This helps ensure an even distribution of moisture to the surface.

-Clean the doors, handles and cabinet surfaces with a mild detergent and then wiped dry with a soft cloth.

Caution!

-Don't use sharp objects as they are likely to scratch the surface.

-Don't use Thinner, Car detergent, Clorox, ethereal oil, abrasive cleansers or organic solvent such as Benzene for cleaning. They may damage the surface of the appliance and may cause fire.

Interior cleaning

You should clean the appliance interior regularly. It will be easier to clean when food stocks are low.

-Wipe the inside of the fridge freezer with a weak solution of bicarbonate of soda, and then rinse with warm water using a wrung-out sponge or cloth.

-Wipe completely dry before replacing the shelves and baskets. Thoroughly dry all surfaces and removable parts.

Although this appliance automatically defrosts, a layer of frost may occur on the refrigerator's interior walls if the door is opened frequently or kept open too long. If the frost is too thick wait until food stocks are low and proceed as follows:

1. Remove existing food and accessories baskets, unplug the appliance from the mains power and leave the doors open. Ventilate the room thoroughly to accelerate the thawing process.

2. When defrosting is completed, clean your freezer as described above.

Caution! Don't use sharp objects to remove frost from the refrigerator. Only after the interior is completely dry should the appliance be switched back on and plugged back into the mains socket.

Door seal cleaning

Take care to keep door seals clean. Sticky food and drinks can cause seals to stick to the cabinet and tear when you open the door. Wash seal with a mild detergent and warm water. Rinse and dry it thoroughly after cleaning.

Caution! Only after the door seals are completely dry should the appliance be powered on.

Replacing the LED light

Warning: The LED light should not be replaced by the user. If the LED light is faulty, contact the customer helpline for assistance.

To replace the LED light, the following steps can be used:

1. Unplug your appliance.
2. Remove light cover by pushing up and out.
3. Hold the LED cover with one hand and pull it with the other hand while pressing the connector latch.
4. Replace LED light and snap it correctly in to place.

Troubleshooting

If you experience a problem with your appliance or are concerned that the appliance is not functioning correctly, you can carry out some easy checks before calling for service, please see below. You can carry out some easy checks according to this section before calling for service.

Warning! Don't try to repair the appliance yourself. If the problem persists after you have made the checks mentioned below, contact a qualified electrician, authorized service engineer or the shop where you purchased the product.

Problem	Possible cause & Solution
Appliance is not working correctly	Check whether the power cord is plugged into the power outlet properly.
	Check whether the “Power” function is on by pressing the “power” button for 1 second.
	Check the fuse or circuit of your power supply, replace if necessary.
	The ambient temperature is too low. Try setting the chamber temperature to a colder level to solve this problem.
	It is normal that the refrigerator is not operating during the automatic defrost cycle, or for a short time after the appliance is switched on to protect the compressor.
Odours from the compartments	The interior may need to be cleaned.
Noise from the appliance	<p>The sounds below are quite normal:</p> <ul style="list-style-type: none"> ● Compressor running noises. ● Air movement noise from the small fan motor in the fridge compartment or other compartments. ● Gurgling sound similar to water boiling. ● Popping noise during automatic defrosting. ● Clicking noise before the compressor starts.
	<p>Other unusual noises are due to the reasons below and may need you to check and take action:</p> <ul style="list-style-type: none"> ● The cabinet is not level. ● The back of appliance touches the wall. ● Bottles or containers fallen or rolling.
The motor runs continuously	<p>It is normal to frequently hear the sound of the motor, it will need to run more when in following circumstances:</p> <ul style="list-style-type: none"> ● Temperature setting is set colder than necessary ● A large quantity of warm food has recently been stored within the appliance. ● The temperature outside the appliance is too high. ● Doors are kept open too long or too often. ● After your installing the appliance or it has been switched off for a long time.
A layer of frost occurs in the compartment	Check that the air outlets are not blocked by food and ensure food is placed within the appliance to allow sufficient ventilation. Ensure that door is fully closed. To remove the frost, please refer to cleaning and care chapter.
Temperature inside is too warm	You may have left the doors open too long or too frequently; or the doors are kept open by some obstacle; or the appliance is located with insufficient clearance at the sides, back or top.

Disposal of the appliance

It is prohibited to dispose of this appliance as household waste.

Packaging materials

Packaging materials with the recycle symbol are recyclable. Dispose of the packaging into a suitable waste collection container to recycle it.

Before disposal of the appliance

1. Pull out the mains plug from the mains socket.
2. Cut off the power cord and discard with the mains plug.

Warning! Refrigerators contain refrigerant and gases in the insulation. Refrigerant and gases must be disposed of professionally as they may cause eye injuries or ignition. Ensure that tubing of the refrigerant circuit is not damage prior to proper disposal.

	Correct Disposal of this product
	<p>This marking indicates that this product should not be disposed with other household wastes throughout the EU. To prevent possible harm to the environment or human health from uncontrolled waste disposal, recycle it responsibly to promote the sustainable reuse of material resources. To return your used device, please use the return and collection systems or contact the retailer where the product was purchased. They can take this product for environmental safe recycling.</p>

220-240V~, 50Hz, R600a ;

For Service please call : 0844 346 0087



Hisense UK Ltd
Unit 2 Meadow Court
Millshaw Lane
Leeds
LS11 8LZ