

# Hisense

life reimagined

## USER'S OPERATION MANUAL

Before operating this unit, please read this manual thoroughly, and retain for future reference

RL170D4BC21  
RL170D4BW21

English



## Contents

Safety and warning information.....	2	Cleaning and care.....	13
Description of the appliance .....	8	What to do if... .....	14
Control panel.....	8	Reversing the door.....	15
First use an installation.....	9	Installing the door handle.....	16
Daily use.....	11	Disposal of the appliance.....	17
Helpful hints and tips.....	12		



## Safety and warning information

For your safety and correct usage, before installing and first using the appliance, read this user manual carefully, including its hints and warnings. To avoid unnecessary mistakes and accidents, it is important to make sure that all people using the appliance are thoroughly familiar with its operation and safety features. Save these instructions and be sure that they remain with the appliance if it is moved or sold, so that anyone using it throughout its life, will be properly informed on its usage and safety notices.

For the safety of life and property, keep the precautions of these user's instructions as the manufacturer is not responsible for damages caused by omission.

### **Safety for children and others who are vulnerable people**

#### ● According to EN standard

This appliance can be used by children aged from 8 years and above and persons with reduced physical, sensory or mental capabilities or lack of experience and knowledge if they have been given supervision or instruction concerning use of the appliance in a safe way and understand the hazards involved. Children shall not play with the appliance. Cleaning and user maintenance shall not be made by children without supervision.

#### According to IEC standard

This appliance is not intended for use by persons (including children) with reduced physical, sensory or mental capabilities, or lack of experience and knowledge, unless they have been given supervision or instruction concerning use of the appliance by a person responsible for their safety.

- Keep all packaging away from children as there is risk of suffocation.
- If you are discarding the appliance, pull the plug out of the socket, cut the connection cable (as close to the appliance as you can) and remove the door to prevent children playing from suffering an electric shock or from closing themselves inside it.
- If this appliance, featuring a magnetic door seals, is to replace an older appliance having a spring lock (latch) on the door or lid, be sure to make the spring lock unusable before you discard the old appliance. This will prevent it from becoming a death trap for a child.

### **General safety**



- **WARNING** — This appliance is intended to be used in household and similar applications such as
  - staff kitchen areas in shops, offices and other working environments;
  - farm houses and by clients in hotels, motels and other residential type environments;
  - bed and breakfast type environments;
  - catering and similar non-retail applications.
- **WARNING** — Do not store explosive substances such as aerosol cans with a flammable propellant in this appliance.
- **WARNING** — If the supply cord is damaged, it must be replaced by the manufacturer, its service agent or similarly qualified persons in order to avoid a hazard.
- **WARNING** — Keep ventilation openings, in the appliance enclosure or in the built-in structure, clear of obstruction.
- **WARNING** — Do not use mechanical devices or other means to accelerate the defrosting process, other than those recommended by the manufacturer.
- **WARNING** — Do not damage the refrigerant circuit.
- **WARNING** — Do not use electrical appliances inside the food storage compartments of the appliance, unless they are of the type recommended by the manufacturer.

- 
- **WARNING** — The refrigerant and insulation blowing gas are flammable. When disposing of the appliance, do so only at an authorized waste disposal centre. Do not expose to flame.
  - **WARNING** —When positioning the appliance, ensure the supply cord is not trapped or damaged.
  - **WARNING** —Do not locate multiple portable socket-outlets or portable power supplies at the rear of the appliance.

## Replacing the illuminating lamps

- **WARNING**—The illuminating lamps must not be replaced by the user! If the illuminating lamps is damaged, contact the customer helpline for assistance.

This warning is only for refrigerators that contain illuminating lamps.

## Refrigerant

The refrigerant isobutene (R600a) is contained within the refrigerant circuit of the appliance, a natural gas with a high level of environmental compatibility, which is nevertheless flammable. During transportation and installation of the appliance, ensure that none of the components of the refrigerant circuit becomes damaged.

The refrigerant (R600a) is flammable.

- **WARNING** — Refrigerators contain refrigerant and gases in the insulation. Refrigerant and gases must be disposed of professionally as they may cause eye injuries or ignition. Ensure that tubing of the refrigerant circuit is not damage prior to proper disposal.



**WARNING: risk of fire**

If the refrigerant circuit should be damaged:

-Avoid opening flames and sources of ignition.

-Thoroughly ventilate the room in which the appliance is situated.

It is dangerous to alter the specifications or modify this product in any way.

Any damage to the cord may cause a shortcircuit, fire, and/or electric shock.



### **Electrical safety**

1. The power cord must not be lengthened.
2. Make sure that the power plug is not crushed or damaged. A crushed or damaged power plug may overheat and cause a fire.
3. Make sure that you can access the main plug of the appliance.
4. Do not pull the main cable.
5. If the power plug socket is loose, do not insert the power plug. There is a risk of electric shock or fire.
6. You must not operate the appliance without the interior lighting lamp cover.
7. The fridge is only applied with power supply of single phase alternating current of 220~240V/50Hz. If fluctuation of voltage in the district of user is so large that the voltage exceeds the above scope, for safety sake, be sure to apply A.C. Automatic voltage regulator of more than 350W to the fridge. The fridge must employ a special power socket instead of common one with other electric appliances. Its plug must match the socket with ground wire.

### **Daily use**

- Do not store flammable gass or liquids in the appliance, There is a risk of an explosion.
- Do not operate any electrical appliances in the appliance (e.g. electric ice cream makers, mixers etc.).
- When unplugging always pull the plug from the mains socket, do not pull on the cable.
- Do not place hot items near the plastic components of this appliance.

- 
- Do not place food products directly against the air outlet on the rear wall.
  - Store pre-packed frozen food in accordance with the frozen food manufacture's instructions.
  - The appliances manufactures storage recommendations should be strictly adhered to. Refer to relrelevant instructions for storage.
  - Do not place carbonated or fizzy drinks in the freeze compartment as it creates pressure on the container, which may cause it to explode, resulting in damage to the appliance.
  - Frozen food can cause frost burns if consumed straight from the freezer compartment.
  - Do not place the appliance in direct sunlight.
  - Keep buring candles, lamps and other items with naked flames away from the appliance so that do not set the appliance on fire.
  - The appliance is intended for keeping food stuff and/or beverages in normal household as explained in this instruction booklet The appliance is heavy. Care should be taken when moving it.
  - Do not remove nor touch items from the freezer compartment if your hands are damp/wet, as this could cause skin abrasions or frost/freezer burns.
  - Never use the base, drawers, doors etc. to stand on or as supports.
  - Frozen food must not be refrozen once it has been thawed out.
  - Do not consume ice popsicles or ice cubes straight from the freezer as this can cause freezer burn to the mouth and lips.
  - To avoid items falling and causing injury or damage to the appliance, do not overload the door racks or put too much food in the crisper drawers.

**caution!**

**Care and cleaning**

- Before maintenance, switch off the appliance and disconnect the mains plug from the mains socket.
- Do not clean the appliance with metal objects, steam cleaner, ethereal oils, organic solvents or abrasive cleansers.
- Do not use sharp objects to remove frost from the appliance. Use a plastic scraper.

### **Installation Important!**

- For electrical connection carefully, follow the instructions given in this manual.  
Unpack the appliance and check if there are damages on it.
- Do not connect the appliance if it is damaged. Report possible damages immediately to the place you bought it. In this case retain packing.
- It is advisable to wait at least four hours before connecting the appliance to allow the oil to flow back in the compressor.
- Adequate air circulation should be around the appliance, lacking this leads to overheating. To achieve sufficient ventilation, follow the instructions relevant to installation.
- Wherever possible the back of the product should not be too close to a wall to avoid touching or catching warm parts (compressor, condenser) to prevent the risk of a fire, follow the instructions relevant to installation.
- The appliance must not be locate close to radiators or cookers.
- Make sure that the mains plug is accessible after the installation of the appliance.

### **Service**

- Any electrical work required to do the servicing of the appliance should be carried out by qualified electrician or competent person.
- This product must be serviced by an authorized Service Center, and only genuine spare parts must be used.
  - 1)If the appliance is Frost Free.
  - 2)If the appliance contains freezer compartment.



## Description of the appliance

### View of the appliance

1. decorative board(some models have)
2. Storage shelf
3. Bulb & temperature regulator
4. Crisper cover
5. Crisper
6. Adjustable feet
7. Egg tray
8. Door handle(some models have)
9. Upper door rack
10. Door
11. Lower door rack

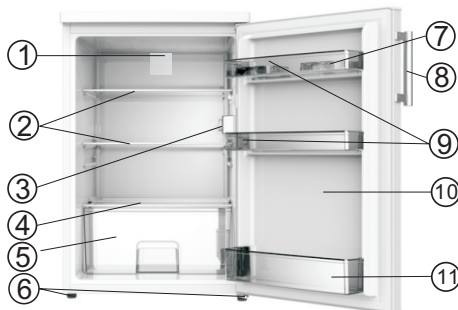

**Note:** Due to continual modification of our products, your refrigerator may be slightly different from this instruction Manual, but its functions and usage methods remain the same.

## Control panel

### Starting up and temperature regulation

Insert the plug of the connection lead into the plug socket with a protective grounding contact. When the refrigerator compartment door is opened, the internal lighting is switched on.

The temperature selector knob is located on the left side of the refrigerator compartment.

#### Setting "0" means

off.

Turning in a clockwise direction the refrigeration unit turns on, it will then operate automatically.

Setting "1" means

Highest temperature, warmest setting.

Setting "7" (end-stop) means

Lowest temperature, coldest setting.

**Important!** Normally, we advise you select a setting of 2, 3 or 4; if you want the temperature higher or lower, please turn the knob to a warmer or colder setting accordingly. When you turn the knob to lower temperature, it can consume more energy while to the higher, it can be more energy-saving and therefore increase the energy efficiency.

**Important!** High ambient temperatures (e.g. on hot summer days) and a cold setting (position 6 to 7) may cause the compressor to run continuously or even non-stop!

**Reason:** When the ambient temperature is high, the compressor must run continuously to maintain the low temperature in the appliance.

### Changing the light bulb



#### Warning!

- Before changing the light bulb, switch off the appliance and unplug it, or pull the fuse or the circuit breaker.

- If the light bulb can't work, please contact your specialist dealer or your local Customer Service Center to change it.

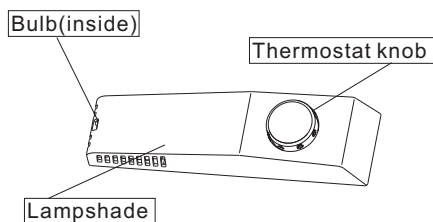

## First use an installation

### Cleaning before use

- Before using the appliance for the first time, wash the interior and all internal accessories with lukewarm water and neutral soap in order to remove the typical smell of a brand new product, then dry thoroughly.

### Installation Positioning



**Warning!** Before installing, read the instruction carefully for your safety and the correct operation of appliance.

- Position the appliance away from sources of heat such as stoves, radiators, direct sunlight, etc.
- Maximum performance and safety are guaranteed by maintaining the correct indoor temperature for the class of unit concerned, as specified on the rating plate.
- This appliance performs well from N to T. The appliance may not work properly if it is left for a longer period at a temperature above or below the indicated range.

Climate class	Ambient temperature
SN	+10°C to +32°C
N	+16°C to +32°C
ST	+16°C to +38°C
T	+16°C to +43°C

**Important!** It is necessary to have good ventilation around the fridge to allow for the dissipation of heat. For this reason, sufficient clear space should be available around the appliance. It is advisable for there to be 50-70mm separating the back of the fridge to the wall at least 100mm of space on its two sides and a clear space in front to allow the doors to open 160°.

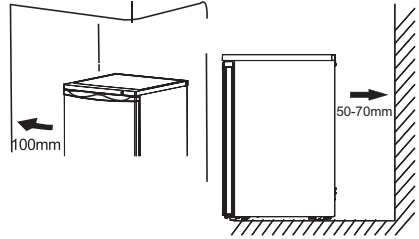

- Appliances must not be exposed to rain. Sufficient air must be allowed to circulate in the low rear section of the appliance, as poor air circulation can affect performance. Built-in appliances should be positioned away from heat sources such as heaters and direct sunlight.

### Installing the rubber supporting

- screw provided in a plastic bag with your appliance, you can install these accessories according to the following procedure.

Note:

There is no need to install these accessories under normal usage.

Only under the extreme circumstances, cabinet empty while load on door with total mass of 15 kg and opening the door about 90 degree, this refrigerator may take risk of tipping. Then rubber supporting pad should be fastened to the lower base cover to steady this appliance.

1. Tilt appliance to find screw hole on the left of lower base cover.

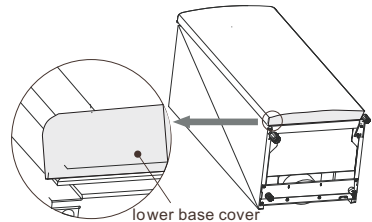

## First use an installation

2. Put screw into the hole of rubber supporting pad.

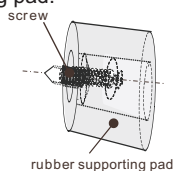

3. Make screw in alignment with the hole on lower base cover. Fasten rubber supporting pad to the base cover firmly by a cross screw driver (self-provided).

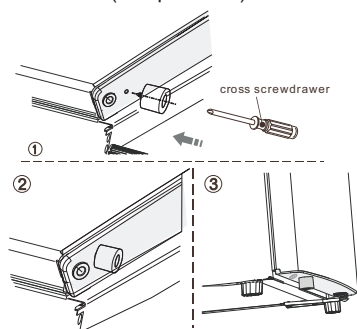

## Leveling

- The appliance should be level in order to eliminate vibration. To make the appliance level, it should be upright and both adjusters should be in stable contact with the floor. You can also adjust the level by unscrewing the appropriate level adjustment in the front (use your fingers or a suitable spanner).

## Electrical connection

**Caution!** Any electrical work required to install this appliance should be carried out by qualified or authorized personnel.

**Warning!** This appliance must be grounded. The manufacturer declines any liability should these safety measures not be observed.

## Daily use

### Accessories <sup>1)</sup>

#### Movable shelves/trays

- Various glass, plastic storage shelves or wire trays are included with your appliance different models have different combinations and different models have different features.
- The walls of the refrigerator are equipped with a series of runner so that the shelves can be positioned as desired.

#### Remove door rack

Hold the left side of the door rack, inward-press the other side and lift this side until it separated from the liner. Then you can take out the door rack from the liner.

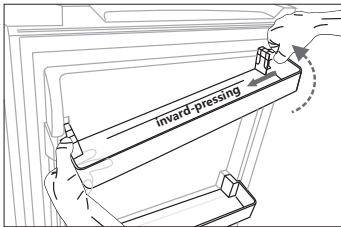

#### Installation door rack

First, install the left of the door rack. Second, inward-press the other side and downward-press this side until installation it.

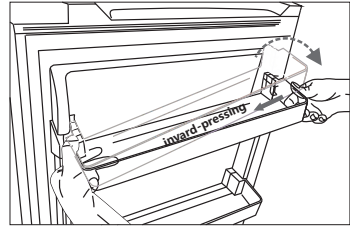

#### Crisper

- For storing fruit and vegetables.

#### Refrigerator compartment <sup>2)</sup>

- For storing the food that does not need to be frozen and different sections suitable for different kinds of food.

- 1) If the appliance contains related accessories and functions.
- 2) If the appliance contains a freezer compartment.

## Helpful hints and tips

### Noises during operation

**Clicks** - Whenever the compressor switches on or off, a click can be heard.

**Humming** - As soon as the compressor is in operation, you can hear it humming.

**Bubbling** - When refrigerant flows into thin tubes, you can hear bubbling or splashing noises.

**Splashing** - Even after the compressor has been switched off, this noise can be heard for a short time.

### Energy saving tips

- Do not install the appliance near stoves, radiators or other sources of warmth.
- Keep the time the appliance is open to a minimum.
- Do not set the temperature colder than necessary.
- Make sure the side plates and back plate of the appliance are at some distance from the wall, and follow the instructions relevant to installation.
- If the diagram shows the correct combination for the drawers, crisper and shelves, do not adjust the combination as it would produce an effect on energy consumption.

### Hints for fresh food refrigeration

- Do not store warm foods or evaporating liquids in the appliance.
- Do cover or wrap the food, particularly if it has strong flavor or odor.
- Position food so that air can circulate freely around it.

### Hints for refrigeration

- Meat (all types): wrap in polyethylene (plastic) bags and place on the glass shelf above in this way only on or two days at the most.
- Cooked foods, cold dishes, etc...: these should be covered and may be placed on any shelf.
- Fruit and vegetables: these should be thoroughly cleaned and placed in the special drawer provided.
- Butter and cheese: these should be placed in aluminum foil or polyethylene (plastic) bags while removing as much air as possible.
- Milk bottles: these should have a cap and should be stored in the bottle rack on the door.

## Cleaning and care

### Cleaning and care

For hygienic reasons, the appliance interior, including interior accessories, should be cleaned regularly.

The appliance should be cleaned and maintained at least every two months.



**Warning!** Danger of electrical shock!

- The appliance should not be connected to the main power supply during cleaning. Before cleaning, switch the appliance off and remove the plug from the main power supply, switch off, or shut off the circuit breaker or fuse.

### Notice!

- Remove the food from the appliance before cleaning. Store them in a cool place and keep well covered.
- Never clean the appliance with a steam cleaner. Moisture could accumulate in electrical components.
- Hot vapors can lead to the damage of plastic parts.
- Ethereal oils and organic solvents can attack plastic parts, e.g. lemon juice or the juice from an orange peel, butyric acid, or cleansers that contain acetic acid.
- Do not use any abrasive cleansers.
- Clean the appliance and the interior accessories with a cloth and lukewarm water. Commercially available dish washing detergents may also be used.
- After cleaning, wipe with fresh water and a clean dish cloth.

- Accumulation of dust at the condenser increases energy consumption; clean the condenser at the back of the appliance once a year with a soft brush or a vacuum cleaner. (Only for the outside-condenser product)

- Check the water drain hole on the rear wall of the refrigerator compartment.

- Clear a blocked drain hole with the aid of something like soft green peg, an be careful not to create any damage to the cabinet by sharp objects.

After everything is dry, the appliance back into service.

### Defrosting

#### Defrosting in the fresh food storage compartment

- Water from the defrosting option will automatically be drained into a drip tray through a drain pipe at the back of the appliance.

#### Taking the appliance out of service

- Empty the appliance
- Pull out the power plug
- Clean thoroughly (see section: Cleaning and Care).
- Leave the door open to prevent odours

## What to do if...



**Warning!** Before troubleshooting, disconnect the power supply. Only a qualified electrician or other

personnel must carry out the troubleshooting that is not in the manual.

### Important!

Repairs to the appliance may only be

performed by competent service engineers. Improper repairs can give rise to significant hazards for the user. If your appliance needs repairing, please contact your specialist dealer or your local Customer Service Center.

Problem	possible cause	Solution
Appliance dose not work.	Appliance is not switched on.	Switch on the appliance.
	Main plug is not plugged in or is loose.	Plug the appliance into the electrical socket.
	Fuse has blown or is defective.	Check fuse, replace if necessary.
	Outlet is defective.	Defective parts need to be repaired by an electrician.
Appliance cools too much.	Temperature is set too cold.	Turn the temperature regulator to a warmer setting temporarily.
The food is too warm.	Temperature is not properly adjusted.	Please refer to the "Initial Start Up" section.
	Door was open for an extended period.	Open the door only as long as necessary.
	A large quantity of warm food was placed in the appliance within the last 24 hours.	Turn the temperature regulator to a warmer setting temporarily.
	The appliance is near a heat source.	Please refer to the "Installation Location" section.
Interior lighting dose not work.	Light bulb is defective.	Please look in the "Changing the Light Bulb" section.
Heavy build-up of frost, possibly also on the door seal.	Door seal is not air-tight (possibly after reversing the door) .	Carefully warm the leaking sections of the door seal with a hair dryer (on a cool setting). At the same time, shape the warmed door seal by hand so that it sits correctly.
Unusual noises.	Appliance is not level.	Readjust the feet.
	The appliance is touching the wall or other objects.	Move the appliance slightly.
	A component, e.g. a pipe, on the rear of the appliance is touching another part of the appliance or the wall.	If necessary, carefully bend the component out of the way.
The compressor dose not start immediately after changing the temperature setting.	This is normal, no error has occurred.	The compressor starts after a period of time.
Water on the floor or storage shelves.	Water drain hole is blocked.	Refer the "Cleaning and Care" section.

## Reversing the door

The side in which the door opens can be changed from the right side (as supplied) to the left side, if the installation site allows for it. Tools you will need:

1. 8mm socket driver



2. Cross- shaped screwdriver



3. Putty knife or thin-blade screwdriver



Before you begin, place the fridge on it's back in order to gain access to the base, you should rest it on soft foam packaging or similar material to avoid damaging the cooling pipes at the rear of the fridge.

### Reverse the door

1. stand the fridge, remove the two screws on the back of the top cover, then lift the top cover and place it on a padded surface to prevent scratching.

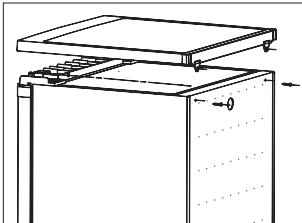

2. Remove the four screws as follow diagram. Lift the upper hinge core ,then put it in a safe place.

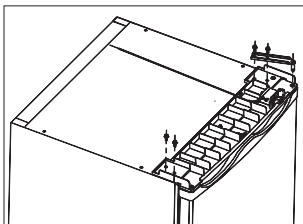

3. Lift the door and place it on a padded surface to prevent scratching. Remove both adjustable feet and remove the bottom hinge bracket by unscrewing the bolts. Then transfer them to another side.

Note: 1. You need move hinge axis from hole ① to ② before transfer.

2. You need install the rubber supporting on the side which haven't hinge.

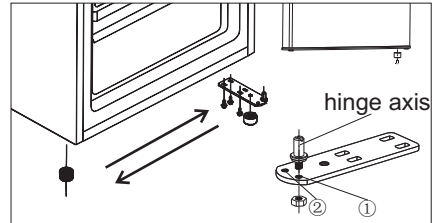

4. Set the door into its new place making sure the pin enters the bushing at the lower frame section. Replace the lid by fitting the upper hinge core into the upper door's hole, securing it with the 2 screws. Replace another 2 screws to another side.

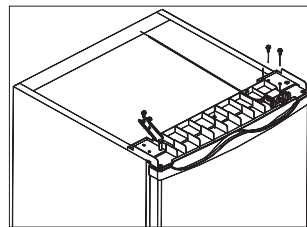

5. Put the top cover in the freezer. Tighten the 2 screws on the back of top cover.

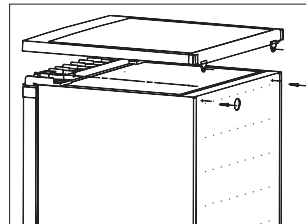

### Warning!

When changing the side at which the door opens, the appliance must not be connected to the mains. Remove plug from the mains beforehand.



## Installing the door handle

If there is door handle separately provided in a plastic bag with your appliance, you can install it as follows .

1. Remove the screw on the door.Keep or install the screw covers on the side which have hinge.

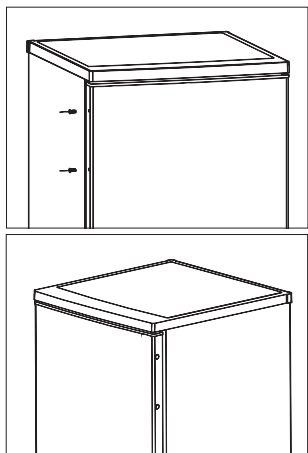

2. Match the handle hole to the door , then fix the screw which you removed from the door to make the handle fixed firmly on the door.

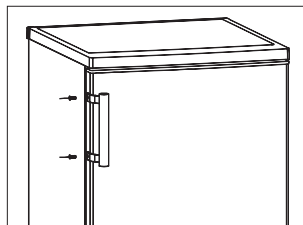

## Disposal of the appliance

It is prohibited to dispose of this appliance in domestic household waste.

### Packaging materials

Packaging materials with the recycle symbol are recyclable. Dispose of the packaging in a suitable waste collection container to recycle it.

### Before disposal of the appliance.

1. disconnect the main plug from the main socket.
2. Cut off the main cable and discard it.

	<b>Correct Disposal of this product</b>
	<p>This marking indicates that this product should not be disposed with other household wastes throughout the EU. To prevent possible harm to the environment or human health from uncontrolled waste disposal, recycle it responsibly to promote the sustainable reuse of material resources. To return your used device, please use the return and collection systems or contact the retailer where the product was purchased. They can take this product for environmental safe recycling.</p>

**Hisense Service Help Line:0844 3460087**

# **Hisense**

life reimagined

Hisense UK Ltd  
Unit 2 Meadow Court  
Millshaw Lane  
Leeds  
LS11 8LZ

4097176