

GB

IE

MT

**DETAILED
INSTRUCTIONS
FOR USE OF THE
ELECTRIC OVEN**

Hisense

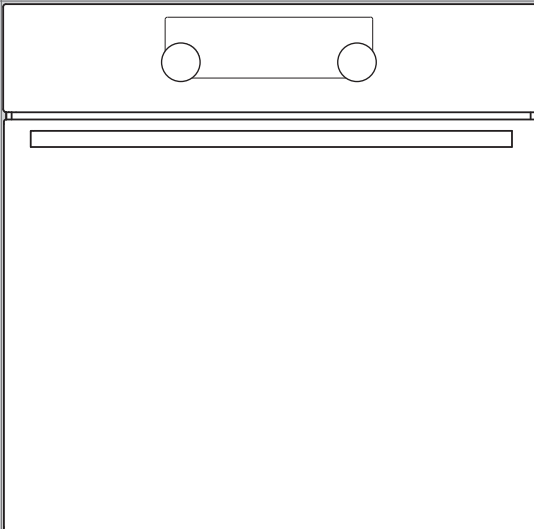

We thank you for your trust and the purchase of our appliance.

This detailed instruction manual is supplied to make the use of this product easier. The instructions should allow you to learn about your new appliance as quickly as possible.

Make sure you have received an undamaged appliance. If you do find transport damage, please contact the seller from which you purchased the appliance, or the regional warehouse from which it was supplied. The telephone number can be found on the invoice or on the delivery note.

Instructions for installation and connection are supplied on a separate sheet.



Important information



Tip, note

CONTENTS

4 IMPORTANT SAFETY INSTRUCTIONS 6 Before connecting the appliance	INTRODUCTION
7 THE ELECTRIC OVEN 11 Technical specifications 12 Control unit (depending on the model)	
14 BEFORE USING THE APPLIANCE FOR THE FIRST TIME	PREPARING THE APPLIANCE FOR THE FIRST USE
15 STEPS OF THE COOKING PROCESS (1-6) 15 Step 1: SWITCHING ON AND SETTINGS 16 Step 2: CHOOSING THE COOKING SYSTEM 18 Step 3: CHOOSING THE SETTINGS 21 Step 4: SELECTING ADDITIONAL FUNCTIONS/EXTRAS 23 Step 5: STARTING THE COOKING PROCESS 23 Step 6: SWITCHING OFF THE OVEN	COOKING STEPS
24 DESCRIPTIONS OF SYSTEMS (COOKING MODES) AND COOKING TABLES	
41 MAINTENANCE & CLEANING 42 Conventional oven cleaning 43 Using the steam clean function to clean the oven 44 Removing and cleaning wire and telescopic extendable guides 45 Installing the catalytic inserts 46 Removing and inserting the oven door (depending on the model) 49 Removing and inserting the oven door glass pane 50 Replacing the bulb	MAINTENANCE & CLEANING
51 TROUBLESHOOTING TABLE	TROUBLE-SHOOTING
52 DISPOSAL	

IMPORTANT SAFETY INSTRUCTIONS



CAREFULLY READ THE INSTRUCTIONS AND SAVE THEM FOR FUTURE REFERENCE.

This appliance may only be used by children aged 8 years and above and persons with reduced physical, sensory or mental capabilities or lack of experience and knowledge if supervision or instructions are provided to them concerning use of the appliance in a safe way and if they understand the hazards involved. Do not let the children play with the appliance. Cleaning and user maintenance shall not be made by children without supervision.

WARNING: The appliance and its accessible parts become hot during use. Care should be taken to avoid touching heating elements. Children less than 8 years of age shall be kept away unless continuously supervised.

WARNING: Accessible parts may become hot during use. Young children should be kept away.

During use the appliance becomes hot. Care should be taken to avoid touching heating elements inside the oven.

Only use the temperature probe recommended for use in this oven.

WARNING: Ensure that the appliance is switched off before replacing the lamp to avoid the possibility of electric shock.

Do not use harsh abrasive cleaners or sharp metal scrapers to clean the oven door glass/ the glass of hinged lids of the hob (as appropriate), since they can scratch the surface, which may result in shattering of the glass.

Do not use steam cleaners or high pressure cleaners to clean the appliance as this may result in an electric shock.

Means for disconnection must be incorporated in the fixed wiring in accordance with the wiring rules.

If the supply cord is damaged, it must be replaced by the manufacturer, its service agent or similarly qualified persons in order to avoid a hazard (only for appliances supplied with connection cord).

The appliance must not be installed behind a decorative door in order to avoid overheating.

The appliance is intended for household use. Do not use it for any other purpose, such as room heating, drying of pets or other animals, paper, fabrics, herbs etc. As this may lead to injury or fire hazard.

The appliance may only be connected to the power mains by an authorised service technician or expert. Tampering with the appliance or non-professional repair thereof may result in risk of severe injury or damage to the product.

If the power cords of other appliances located near this appliance are caught in the oven door, they may be damaged, which may in turn result in a short circuit. Therefore, keep the power cords of other appliances at a safe distance.

Do not line the oven walls with aluminium foil and do not place baking trays or other cookware on the oven bottom. Aluminium foil would prevent air circulation in the oven, hinder the cooking process, and ruin the enamel coating.

Oven door become very hot during operation. A third glass is installed for extra protection, reducing the temperature of the outside surface (only with some models).

Oven door hinges may be damaged when under excessive load. Do not place heavy pans on open oven door and do not lean against open oven door when cleaning the oven cavity. Never stand on the open oven door and do not let children to sit on it.

Do not lift the appliance by holding it by the door handle.

Appliance operation is safe with and without tray guides.

Make sure the vents are never covered or obstructed in any other way.

BEFORE CONNECTING THE APPLIANCE:



Carefully read the instructions for use before connecting the appliance. Repair or any warranty claim resulting from incorrect connection or use of the appliance shall not be covered by the warranty.

THE ELECTRIC OVEN

(DESCRIPTION OF THE OVEN AND EQUIPMENT - DEPENDING ON THE MODEL)

The figure represents one of the built-in appliance models. Since the appliances for which these instructions were drawn up may have different equipment, some functions or equipment may be described in the manual that may not be present in your appliances.

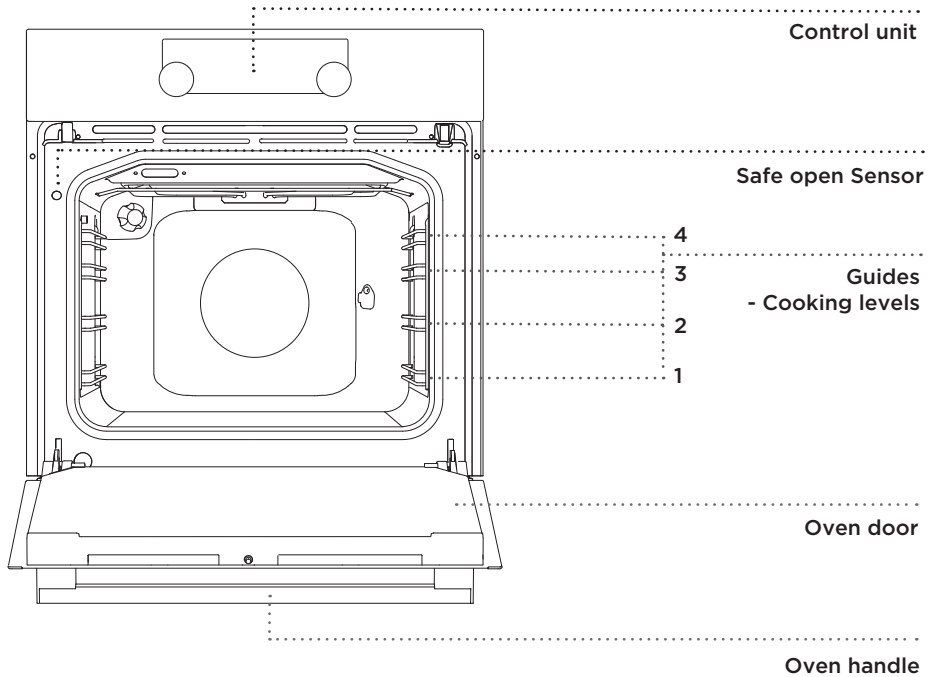

PUSH-PULL KNOB

Slightly push the knob until it pops out; then, rotate it.



After each use, rotate the knob back to the "off" position and push it back in. The push-pull knob can only be pushed back when the switch is in the "off" position.

WIRE GUIDES

The wire guides allow preparation of the food on four levels (please note that the levels/guides are counted from the bottom up).

Guides 3 and 4 are intended for grilling.

TELESCOPIC PULL-OUT GUIDES

Telescopic pull-out guides may be fitted for the 2nd, 3rd, and 4th level.

Pull-out guides can be partly or fully extendable.

SAFE OPEN SENSOR

The sensor deactivates oven heating and the fan when the oven door is opened during the cooking process. When the door is closed, the sensor turns the heaters back on.

COOLING FAN

The appliance is fitted with a cooling fan that cools the housing and the appliance control panel.

EXTENDED OPERATION OF THE COOLING FAN

After the oven is switched off, the cooling fan continues to operate for a short while in order to cool the oven.

OVEN EQUIPMENT AND ACCESSORIES (depending on the model)

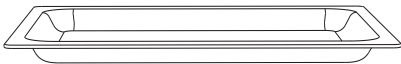

GLASS BAKING DISH is used for cooking with all oven systems. It can also be used as a serving tray.

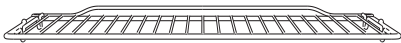

The **GRID** is used for grilling or as support for a pan, baking tray or baking dish with the food.



There is a safety latch on the grid. Therefore, lift the grid slightly at the front when pulling it out from the oven.

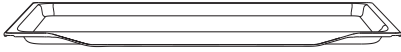

The **SHALLOW BAKING SHEET** is used for baking pastry and cakes.

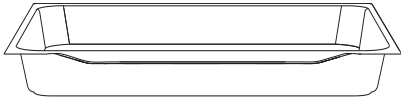

The **DEEP BAKING TRAY** is used for roasting meat and baking moist pastry. It can also be used as a drip tray.



Never place the deep baking tray in the first guide during the cooking process, except when grilling food or using the roasting spit and you are only using the deep tray as a drip tray.



As baking accessories heat up, their form may change. This does not affect their functionality and their original form will be restored when they cool down.

The grid or the tray should always be inserted into the groove between the two wire profiles.

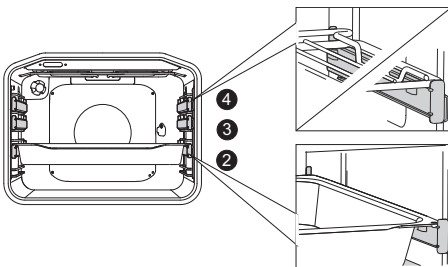
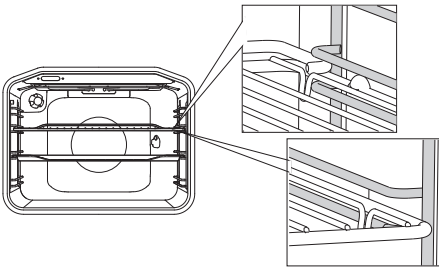

With telescopic extendable guides, first pull out the guides of one level and place the grid or the baking tray onto them. Then, push them in with your hand as far as they will go.



Close the oven door when the telescopic guides are retracted all the way into the oven.

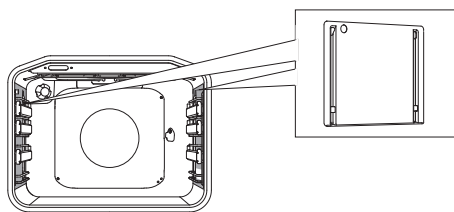

CATALYTIC INSERTS prevent the spraying fat from accumulating on the sides of the oven cavity.

1 WHAT IS CATALYSIS?

Catalytic cleaning is a chemical process in which catalysts completely break down the grease particles during food preparation. In case of normal use, the service life of the catalytic inserts is equal to the service life of the appliance. If the inserts are worn out sooner, replacements are available at service centres.

2 HOW TO CLEAN THE CATALYTIC INSERTS?

Catalytic inserts are cleaned automatically at temperatures of 85 °C or higher. In case of minor stains, they can be easily removed and cleaned with water and a soft cloth. Do not use aggressive cleaners and do not wash the inserts in the dishwasher. Streaks on the catalytic inserts do not affect their effectiveness.



The appliance and some of the accessible parts tend to heat up during cooking. Use oven mitts.

TECHNICAL SPECIFICATIONS

(DEPENDING ON THE MODEL)

XXXXXX	220-240V ~	P _{nmax} : 3.5 kW	TN XXXXX
TYPE: XXXXXX	220V-240V, 50/60Hz		
ART. Nr:			
SER. Nr: XXXXXX			

The rating plate indicating the basic information about the appliance is located at the edge of the oven and it is visible when the oven door is opened.

CONTROL UNIT

(DEPENDING ON THE MODEL)

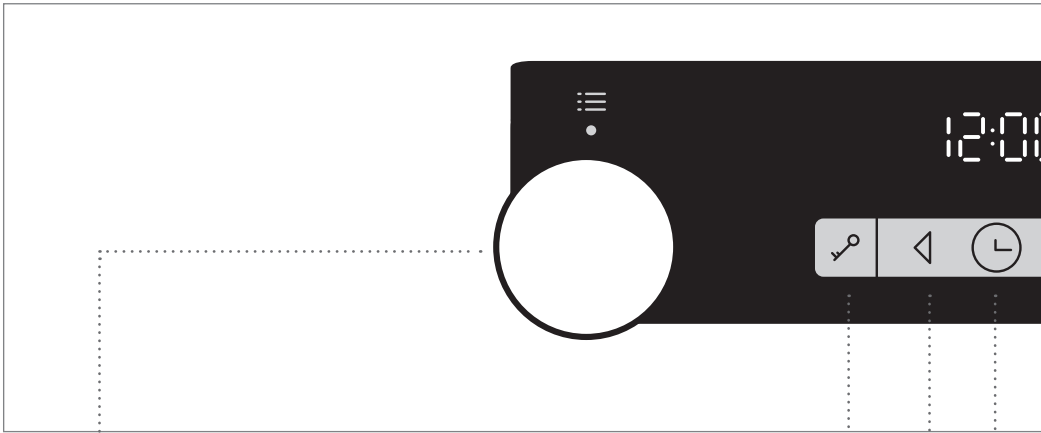

1 COOKING
SYSTEM
SELECTOR KNOB

2 CHILD LOCK
KEY

3 VALUE
DECREASE KEY

4 CLOCK KEY

NOTE:

Symbols of cooking systems may be located on the knob or on the front panel (depending on the appliance model).

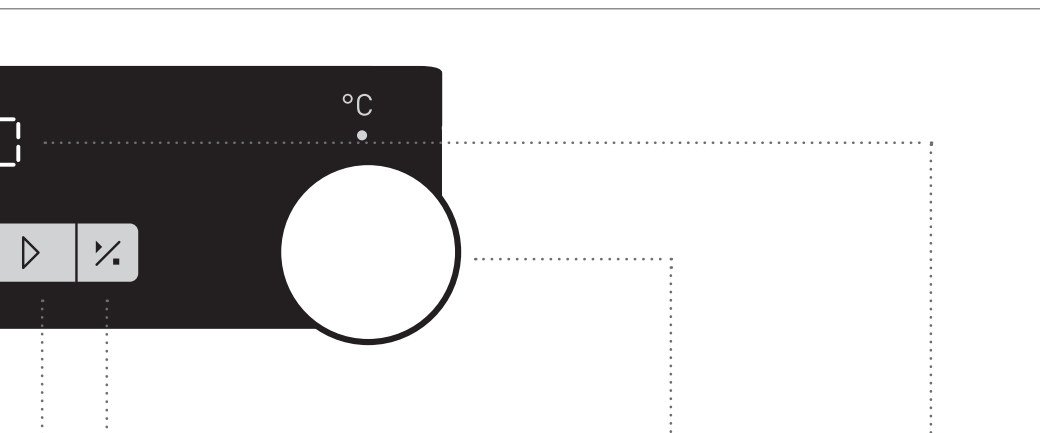

5 VALUE
INCREASE KEY

6 START/STOP
KEY to start or
pause a program

7 TEMPERATURE
KNOB

8 TIME DISPLAY

NOTE:

The keys will respond better if you touch them with a larger area of your fingertip. Each time you press a key, a short acoustic signal will be sounded.

BEFORE USING THE APPLIANCE FOR THE FIRST TIME

Upon receiving the appliance, remove all parts, including any transport equipment, from the oven.

Clean all accessories and utensils with warm water and regular detergent. Do not use any abrasive cleaners.

When the oven heats up for the first time, the characteristic smell of a new appliance will be emitted. Ventilate the room thoroughly during the first use.

STEPS OF THE COOKING PROCESS (1-6)

STEP 1: SWITCHING ON AND SETTINGS

After connecting your appliance or after an extended power outage, 12:00 will flash on the display and the symbol will light up ☹.

Set the time of day.

SETTING THE CLOCK

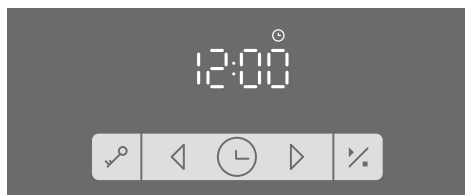

1 Touch the < or > keys to set the time of day.

 If you press and hold the value adjustment key, the rate at which the set value is being changed will increase.

CHANGING THE CLOCK SETTING

Clock settings may be changed when no timer function is activated. To set the current time (clock), touch the CLOCK key several times to select the ☹ symbol.

STEP 2: CHOOSING THE COOKING SYSTEM

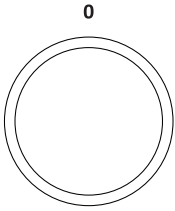









Rotate the knob (left and right) to select the cooking system (see program table, depending on the model).



Settings can also be changed during the cooking process.

SYSTEM	DESCRIPTION	SUGGESTED TEMPERATURE °C
COOKING SYSTEMS		
	PREHEAT ASSIST Use this function if you wish to heat the oven to the desired temperature as quickly as possible. This function is not appropriate for cooking food. When the oven heats up to the desired temperature, the heating process is completed.	160
	UPPER AND BOTTOM HEATER The heaters in the bottom and in the ceiling of the oven cavity will radiate heat evenly into the oven interior. Pastry or meat can only be baked/roasted at a single height level.	200
	TOP HEATER Only the heater on the oven cavity ceiling will radiate heat onto the food. Use it to brown the upper side of your dish (final browning).	180
	BOTTOM HEATER Only the heater on the bottom of the oven cavity will radiate heat. Use this heater to brown the lower side of the dish.	180
	GRILL Only grill heater, a part of the large grill set, will operate. This system is used for grilling a smaller amount of open sandwiches or beer sausages, and for toasting bread.	230
	LARGE GRILL The upper heater and the grill heater will operate. The heat is radiated directly by the grill heater installed in the oven ceiling. To boost the heating effect, the upper heater is activated as well. This combination is used for grilling a smaller amount of open sandwiches, meat or beer sausages, and for toasting bread.	230
	GRILL WITH FAN Grill heater and the fan will operate. This combination is used to grill meat and to roast larger chunks of meat or poultry at a single height level. It is also appropriate for dishes au gratin and for browning to a crispy crust.	170
	TOP HEATER AND FAN The top (upper) heater and the fan will operate. Use this system to roast larger chunks of meat and poultry. It is also suitable for dishes au gratin.	170

SYSTEM	DESCRIPTION	SUGGESTED TEMPERATURE °C
	HOT AIR AND BOTTOM HEATER The bottom heater, the round heater, and the hot air fan will operate. This is used to bake pizza, moist pastry, fruitcakes, leavened dough and shortcrust on several levels simultaneously.	200
	HOT AIR Round heater and the fan will operate. The fan installed in the back wall of the oven cavity makes sure the hot air constantly circulates around the roast or pastry. This mode is used for roasting meat and baking pastry at several levels simultaneously.	180
	BOTTOM HEATER AND FAN This is used for baking leavened but low-rising pastry and for preserving fruit and vegetables.	180
	TOP AND BOTTOM HEATER WITH FAN Both heaters and the fan are activated. The fan allows even circulation of hot air inside the oven. It is used for baking pastry, for defrosting, and for drying fruit and vegetables.	180
	PLATE WARMER Use this function to reheat your dinnerware (plates, cups) before serving food in it to keep the food warm longer.	60
	GENTLEBAKE ¹⁾ This feature allows gentle, slow, and even baking that leaves the food soft and juicy. It is suitable for roasting meat, cooking fish, and baking pastry on a single rack. Set the temperature in the range from 140 to 220 °C.	180
	STEAM CLEAN Only the bottom heater will radiate heat. Use this function to remove stains and food residues from the oven. The program takes 30 minutes.	-
	DEFROSTING The air circulates with no heaters activated. Only the fan will be activated. This is used to slowly thaw frozen food.	-



¹⁾ It is used for determining the energy efficiency class pursuant to the EN 60350-1 standard.

 With these systems, you can cook with the addition of steam – see chapter DESCRIPTIONS OF SYSTEMS/COOKING MODES AND COOKING TABLE FOR PROGRAMS WITH STEAM ADDITION.

STEP 3: CHOOSING THE SETTINGS

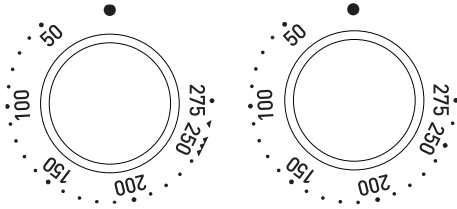
ADJUSTING THE COOKING TEMPERATURE



 When using the oven system with the large grill and grill, set the temperature knob to position .

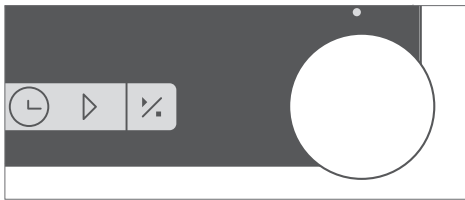

Rotate the knob to set the desired TEMPERATURE.

After switching on the appliance by touching the START key, the temperature icon is displayed on the display unit.

 To switch on the appliance, press the START key and hold it for a while – about 1 second.

TIMER FUNCTIONS

First rotate the COOKING SYSTEM SELECTOR KNOB; then, set the temperature.

Touch the TIMER key several times to select the desired timer function.

The icon for the selected timer function will light up and the adjustable cooking start/end time will flash on the display.

Press START to start the cooking process. ELAPSED COOKING TIME will be displayed.



Timer function display



Setting the cooking time

In this mode, you can define the duration of oven operation (cooking time). Set the desired cooking time. First set the minutes, then the hours. Icon and cooking time are displayed on the display unit.



Setting the delayed start

In this mode, you may specify the duration of the cooking process (cooking time) and the time when you wish the cooking process to stop (end time). Make sure the clock is accurately set to current time.

Example:

Current time: noon

Cooking time: 2 hours

End of cooking: 6 pm

First set the OPERATION DURATION (2 hours). Touch the CLOCK button twice to select the END OF OPERATION. The display automatically shows a flashing sum of the time of day and duration of operation of the oven (14:00).

Set the time for the end of baking (18:00)

Press START to start the cooking process. The timer will wait for the time to start the cooking process and the symbol will be lit up. The oven automatically switches on (at 4 pm) and stops operating and the selected time (at 6 pm).



Setting the minute minder

The minute minder can be used independently of the oven operation. The longest possible setting is 24 hours. During the last minute, the minute minder is displayed in seconds.



After the set time expires, the oven will automatically stop operating (end of cooking). An acoustic signal will be heard which you may turn off by touching any key. After one minute, the acoustic signal will be switched off automatically.

Timer functions can be cancelled by setting the time to "0". Any timer function may also be quickly cancelled by simultaneously pressing the < and > key and holding them for a while.

STEP 4: SELECTING ADDITIONAL FUNCTIONS/EXTRAS

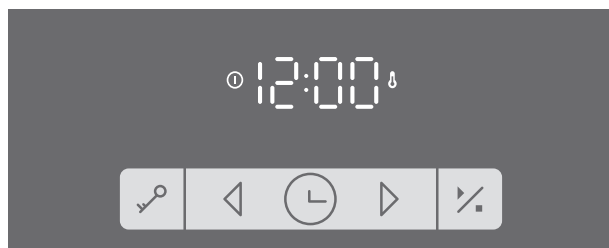

Activate/deactivate the functions by pressing the desired key or a combination of keys.



Certain functions are not available with some systems; an acoustic signal will indicate of such cases.

CHILD LOCK!

Activate it by touching the CHILD LOCK key. "Loc" will appear on the display unit for 5 seconds. Touch the key again to deactivate the child lock.

If the child lock is activated with no timer function engaged (only clock is displayed), then the oven will not operate. If the child lock is activated after a timer function has been set, then the oven will operate normally; however, it will not be possible to change the settings.

When the child lock is activated, the systems can be changed, but it is not possible to change the extra functions. The cooking process can be ended by rotating the selector knob to "O". Child lock will remain active after the oven is switched off. To select a new system, the child lock must first be deactivated.



OVEN LIGHTING

Oven lighting will be switched on automatically each time a cooking system is selected.

5sek < **ACOUSTIC SIGNAL**

Loudness of the acoustic signal can be set when no timer function is activated (only the time of day is displayed).

Press the < key and hold it for five seconds. First, "**Vol**" will appear on the display unit, followed by two fully lit bars. Touch the < and > keys to choose one of the three volume levels (one, two, or three bars). After three seconds, the setting will be automatically stored and the time of day will appear.

5sek > **DECREASING THE DISPLAY CONTRAST**

The cooking system selector knob has to be in position "0".

Hold the > key for 5 seconds. First, "**bri**" will appear on the display unit, followed by two fully lit bars. Touch the < and > keys to adjust the display dimmer (one, two, or three bars). After three seconds, the setting will be automatically saved.

STANDBY

Simultaneously press and hold the "key" and "clock" keys for 5 seconds to switch off the display unit. "OFF" will appear for a few seconds; then, the "CLOCK" icon will light up.

To reactivate the clock display, simultaneously press these two keys while no timer function is active.



After a power outage or after the appliance is switched off, the additional function settings will remain stored for no more than a few minutes. Then, all settings, except for the acoustic signal and child lock will be reset to factory defaults.

STEP 5: STARTING THE COOKING PROCESS

Start the cooking process by pressing the START/STOP key and holding it for a while. Temperature and operation symbols will be lit up.

If no timer function is selected, the cooking duration time, cooking time will appear on the display unit.

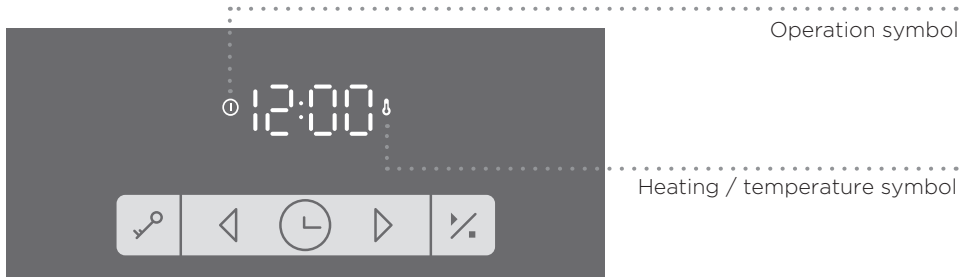



While the oven is heating up, the temperature symbol will flash. When the oven reaches the set temperature, the symbol will light up and a short beep will be sounded.

STEP 6: SWITCHING OFF THE OVEN

To stop the cooking process, press and hold the START/STOP key.

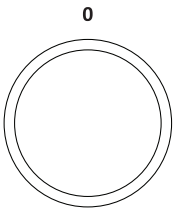
Turn the COOKING SYSTEM SELECTOR and TEMPERATURE KNOB to position "0".



 After the cooking process, all timer settings are also paused and cancelled, except for the minute minder. Time of day (clock) will be displayed. The cooling fan will continue to operate for a while.

 After the use of the oven, some water may be left in the condensate channel (underneath the door). Wipe the channel with a sponge or a cloth.

DESCRIPTIONS OF SYSTEMS (COOKING MODES) AND COOKING TABLES

If your desired food cannot be found in the cooking table, find information for similar food. The information displayed applies to cooking in a single level.

An interval of suggested temperature is indicated. Start with a lower temperature setting and increase it if you find the food is not browned sufficiently.

Cooking times are rough estimates and may vary subject to some conditions.

Only preheat the oven if required by the recipe of in the tables in this instruction manual. Heating an empty oven consumes a lot of energy. Hence, baking several types of pastry or several pizzas successively will save a lot of energy as the oven will already have been preheated.

Use dark, black silicon-layered or enamel-coated baking sheets and trays as they conduct the heat very well.

When using parchment paper, make sure it is resistant to high temperatures.

When cooking larger chunks of meat or pastry, a lot of steam will be generated inside the oven, which in turn may condense on the oven door. This is a normal phenomenon which will not affect the operation of the appliance. After the cooking process, wipe the door and the door glass dry.

Switch off the oven approximately 10 minutes before the end of the cooking process to save energy by making use of the accumulated heat.

Do not cool the food in a closed oven to prevent condensation (dew).

Standard doneness levels and recommended final core temperature for different types of meat

Type of food	Food core temperature (°C)	Meat colour on cross-section, and colour of juices
BEEF		
Rare	40-45	meaty red, like raw meat, little juice
Medium rare	55-60	light red, a lot of light red juice
Medium	65-70	pink, small amount of pale pink juice
Well done	75-80	evenly greyish brown, little colourless juice
VEAL		
Well done	75-85	red-brown
PORK		
Medium	65-70	light pink
Well done	75-85	yellow-brown
LAMB		
Well done	79	grey, pinkish juice
MUTTON		
Rare	45	meaty red
Medium rare	55-60	light red
Medium	65-70	pink in the middle
Well done	80	grey
GOAT MEAT		
Medium	70	pale pink, pink juices
Well done	82	grey, juices only slightly pink
POULTRY		
Well done	82	light grey
FISH		
Well done	65-70	white to grey-brown

COOKING SYSTEMS

UPPER AND BOTTOM HEATER

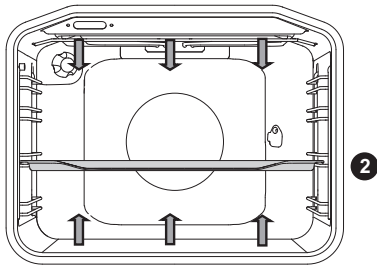

The heaters in the bottom and in the ceiling of the oven cavity will radiate heat evenly into the oven interior.

Roasting meat:

Use enamel coated, tempered glass, clay, or cast iron pan or tray. Stainless steel trays are not suitable as they strongly reflect the heat.

Use enamel coated, tempered glass, clay, or cast iron pan or tray. Stainless steel trays are not suitable as they strongly reflect the heat.

Type of food	Weight (g)	Guide (from the bottom)	Temperature (°C)	Cooking time (minutes)
MEAT				
Pork roast	1500	2	180-200	90-110
Pork shoulder	1500	2	180-200	100-120
Pork roulade	1500	2	180-200	120-140
Meat loaf	1500	2	200-210	60-70
Beef roast	1500	2	170-190	120-140
Veal roulade	1500	2	180-200	90-120
Lamb sirloin	1500	2	180-200	80-100
Rabbit loin	1500	2	180-200	50-70
Deer shank	1500	2	180-200	100-120
Pizza*	/	2	200-220	20-30
Chicken	1500	2	190-210	70-90
FISH				
Braised fish	1000	2	210	50-60

Use this system to roast chicken, if the appliance does not have the  system.

Use this system to bake pizza, if the appliance does not have the  system.

The symbol * means that the oven should be preheated using the selected cooking system.

Baking pastry

Only use one level and dark baking sheets or trays. In light-coloured baking sheets or trays, the browning of the pastry will be poorer, as such equipment will reflect the heat. Always place the baking trays on the grid. If you are using the supplied baking sheet, remove the grid. Cooking time will be shorter if the oven is preheated.

Type of food	Guide (from the bottom)	Temperature (°C)	Cooking time (minutes)
PASTRY			
Vegetable soufflé	2	190-200	30-35
Sweet soufflé	2	190-200	30-35
Rolls*	2	190-210	20-30
White bread*	2	180-190	50-60
Buckwheat bread*	2	180-190	50-60
Whole grain bread*	2	180-190	50-60
Rye bread*	2	180-190	50-60
Spelt bread*	2	180-190	50-60
Walnut cake	2	170-180	50-60
Sponge cake*	2	160-170	25-30
Cheesecake	2	170-180	65-75
Cupcakes	2	170-180	25-30
Small pastries made with yeast dough	2	200-210	20-30
Cabbage pirozhki	2	185-195	25-35
Fruitcake	2	150-160	40-50
Meringue cookies	2	80-90	120-130
Jelly-filled rolls (Buchtel)	2	170-180	30-40

The symbol * means that the oven should be preheated using the selected cooking system.



TOP AND BOTTOM HEATER WITH STEAM

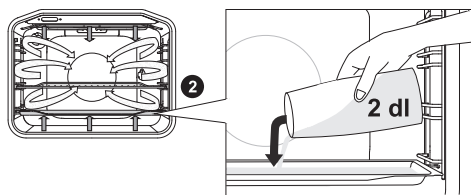

Place a baking sheet into the first guide when the oven is still cool. Pour a maximum of 2 dl of water onto the baking sheet. Place the food to be cooked on the second rack and start the system.



If you are using a deep baking tray, insert it one level higher than specified in the recommended settings table.



For optimum operation of the function, do not open the oven door and do not add water during the cooking process.

Type of food	Weight (g)	Guide (from the bottom)	Temperature (°C)	Cooking time (minutes)
Pork roast	1500	2	180-200	100-120
Pork shoulder	1500	2	180-200	110-130
Meat loaf	1500	2	200-210	70-80
Beef roast	1500	2	170-190	130-150
Chicken	1500	2	190-210	80-100

Tip	Use
Is the cake done?	<ul style="list-style-type: none"> Pierce the cake at the top with a wooden toothpick or skewer. If there are no traces on the pick or the skewer when pulled out, the cake is done.
Did the cake collapse?	<ul style="list-style-type: none"> Check the recipe. Next time, use less liquid. Note the mixing time when using small mixers, blenders etc.
The cake is too light at the bottom?	<ul style="list-style-type: none"> Use a dark-coloured baking sheet or tray. Place the baking sheet one guide lower and switch on the lower heater towards the end of the cooking progress.
Cake with moist stuffing is underdone?	<ul style="list-style-type: none"> Increase temperature and extend baking time.



Do not insert the deep baking tray into the first guide.

LARGE GRILL, GRILL

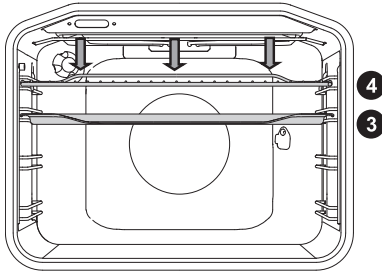

When grilling food with the large grill, the upper heater and the grill heater fitted on the ceiling of the oven cavity will operate.

When grilling food, the upper heater and the grill heater fitted on the ceiling of the oven cavity will operate.

Max allowed temperature : 240°C

Preheat the infrared (grill) heater for five minutes.

Supervise the cooking process at all times. The meat may burn quickly due to high temperature.

When grilling directly on the grid, smear it with oil to prevent the meat from sticking onto it and insert it into the 4th guide. Insert the drip tray in to the 1st or 2nd guide. When grilling in a baking tray, make sure there is enough liquid in the tray to prevent burning. Turn the meat during cooking.

After grilling, clean the oven, the accessories, and the utensils.

Grilling table - small grill

Type of food	Weight (g)	Guide (from the bottom)	Temperature (°C)	Cooking time (minutes)
MEAT				
Beefsteak, rare	180 g/piece	3	230	15-20
Pork neck fillet	150 g/piece	3	230	18-22
Cutlets/chops	280 g/piece	3	230	20-25
Grill sausages	70 g/piece	3	230	10-15
TOASTED BREAD				
Toast	/	4	230	3-6
Open sandwiches	/	4	230	3-6

Grilling table - large grill

Type of food	Weight (g)	Guide (from the bottom)	Temperature (°C)	Cooking time (minutes)
MEAT				
Beefsteak, rare	180 g/piece	3	230	15-20
Beefsteak, well done	180 g/piece	3	230	18-25
Pork neck fillet	150 g/piece	3	230	20-25
Cutlets/chops	280 g/piece	3	230	20-25
Veal escalope	140 g/piece	3	230	20-25
Grill sausages	70 g/piece	3	230	10-15
Spam (Leberkäse)	150 g/piece	3	230	10-15
FISH				
Salmon steaks/fillets	200 g/piece	3	230	15-25
TOASTED BREAD				
Toast	/	4	230	1-3
Open sandwiches	/	4	230	2-5

When grilling in a baking tray, make sure there is enough liquid in the tray to prevent burning. Turn the meat during cooking.

When baking trout, pat the fish dry with a paper towel. Season on the inside; coat with oil on the outside and place on the grid. Do not turn the fish when grilling.



Always keep the oven door closed when using the grill (infrared) heater.

Grill heater, grid, and other oven accessories get very hot during grilling. Therefore, use oven mitts and meat tongs.

GRILL WITH FAN

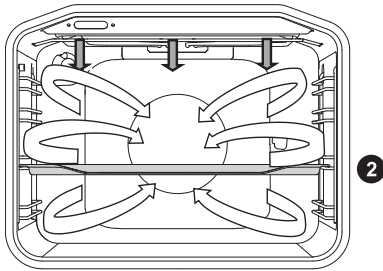

In this operating mode, the grill heater and the fan operate simultaneously. Suitable for grilling meat, fish, and vegetables.

(See descriptions and tips for GRILL.)

Type of food	Weight (g)	Guide level (from the bottom)	Temperature (°C)	Cooking time (min)
MEAT				
Duck	2000	2	150-170	80-100
Pork roast	1500	2	160-170	60-85
Pork shoulder	1500	2	150-160	120-160
Pork shank	1000	2	150-160	120-140
Half of chicken	700	2	190-210	50-60
Chicken	1500	2	190-210	60-90
FISH				
Trout	200 g/piece	2	200-220	20-30



HOT AIR AND BOTTOM HEATER

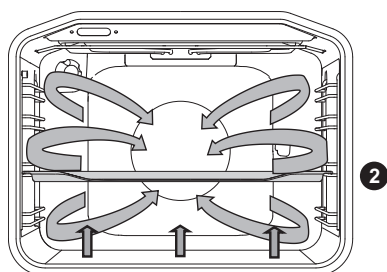

The bottom heater, the round heater, and the hot air fan will operate. Suitable for baking pizzas, apple pies, and fruitcakes.

(See descriptions and tips for UPPER and BOTTOM HEATER.)

Type of food	Guide (from the bottom)	Temperature (°C)	Cooking time (minutes)
Cheesecake, short crust	2	150-160	65-80
Pizza *	2	200-210	15-20
Quiche Lorraine, shortcrust	2	180-200	35-40
Apple pie, leavened dough	2	150-160	35-40
Apple strudel, phyllo dough	2	170-180	45-65

The symbol * means that the oven should be preheated using the selected cooking system.



HOT AIR AND BOTTOM HEATER WITH STEAM

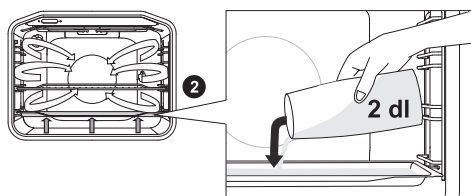

Place a baking sheet into the first guide when the oven is still cool. Pour a maximum of 2 dl of water onto the baking sheet. Place the food to be cooked on the second rack and start the system.

 If you are using a deep baking tray, insert it one level higher than specified in the recommended settings table.

 For optimum operation of the function, do not open the oven door and do not add water during the cooking process.

Type of food	Weight (g)	Guide (from the bottom)	Temperature (°C)	Cooking time (minutes)
White bread *	1000	2	180-190	60-80
Pizza *	/	2	210-220	15-20
Apple and cottage cheese strudel	/	2	180-190	50-60
Pizza; frozen	/	2	200-220	15-20
Apple and cottage cheese strudel; frozen	/	2	200-210	30-40
Chicken breast	1000	2	190-210	60-70

The symbol * means that the oven should be preheated using the selected cooking system.



HOT AIR

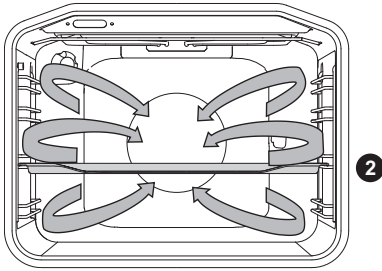

Round heater and the fan will operate. The fan installed in the back wall of the oven cavity makes sure the hot air constantly circulates around the roast or pastry.

Roasting meat:

Use enamel coated, tempered glass, clay, or cast iron pan or tray. Stainless steel trays are not suitable as they strongly reflect the heat.

Provide enough liquid during the cooking process to prevent the meat from burning. Turn the meat during roasting. The roast will remain juicier if you cover it.

Type of food	Weight (g)	Guide (from the bottom)	Temperature (°C)	Cooking time (minutes)
MEAT				
Pork roast, including skin	1500	2	170-180	140-160
Duck	2000	2	160-170	120-150
Goose	4000	2	150-160	180-200
Turkey	5000	2	150-170	180-220
Chicken breast	1000	3	180-200	60-70
Stuffed chicken	1500	2	170-180	90-110

Baking pastry

Preheating is recommended.

Biscuits and cookies can be baked in shallow baking sheets on several levels simultaneously (2nd and 3rd).

Note that baking time can differ even with if the baking sheets used are the same. The biscuits in the upper baking sheet may be ready sooner than those in the lower one.

Always place the baking trays on the grid. If you are using the supplied baking sheet, remove the grid.

For even browning, make sure the biscuits are of the same thickness.

Type of food	Guide (from the bottom)	Temperature (°C)	Cooking time (minutes)
PASTRY			
Sponge cake	2	150-160	25-35
Crumble cake	2	160-170	25-35
Fruit cake, sponge	2	150-160	45-65
Sponge roll*	2	160-170	15-25
Fruit cake, short crust	2	160-170	50-70
Apple strudel	2	170-180	40-60
Biscuits, short crust*	2	150-160	15-25
Biscuits, pressed*	2	140-150	15-25
Cookies, leavened	2	170-180	20-35
Cookies, phyllo dough	2	170-180	20-30
PASTRY – FROZEN			
Apple and cottage cheese strudel	2	170-180	50-70
Pizza	2	170-180	20-30
Fried potatoes, oven-ready	2	170-180	20-35
Croquettes, oven-baked	2	170-180	20-35

The symbol * means that the oven should be preheated using the selected cooking system.



Do not insert the deep baking tray into the first guide.



HOT AIR WITH STEAM

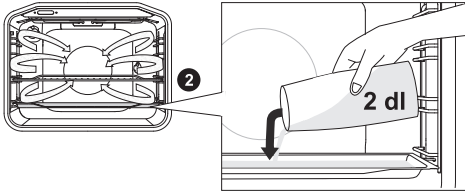

Place a baking sheet into the first guide when the oven is still cool. Pour a maximum of 2 dl of water onto the baking sheet. Place the food to be cooked on the second rack and start the system.



If you are using a deep baking tray, insert it one level higher than specified in the recommended settings table.



For optimum operation of the function, do not open the oven door and do not add water during the cooking process.

Type of food	Weight (g)	Guide (from the bottom)	Temperature (°C)	Cooking time (minutes)
Bread rolls (Semmel)*	/	2	190-210	20-30
Roulade *	/	2	170-180	20-25
"Puff pastry; frozen"	/	2	190-200	20-30
Lasagne, frozen	/	2	190-200	40-50

The symbol * means that the oven should be preheated using the selected cooking system.



BOTTOM HEATER AND FAN

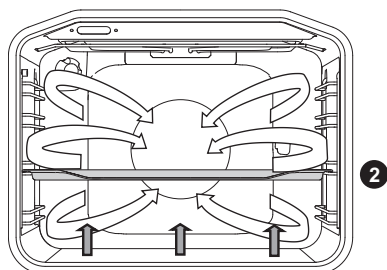

This is used for baking leavened but low-rising pastry and for preserving fruit and vegetables. Use the second guide from the bottom and a rather shallow baking tray to allow the hot air to circulate across the upper side of the dish.

PRESERVATION

Prepare the food to be preserved and jars as usual. Use jars with a rubber sealing ring and a glass cover. Do not use jars with threaded or metal caps or metal tins. Make sure the jars are of equal size, filled with the same contents, and tightly sealed.

Pour 1 litre of hot water into the deep tray (approx. 70°C) and place 6 1-litre jars into the tray. Place the tray into the oven on the second guide.

During preservation, observe the food and cook until the liquid in the jars starts to simmer – when bubbles appear in the first jar.

Type of food	Guide (from the bottom)	Temperature (°C)	Time to simmer (min)	Temperature and time after the start of simmer	Resting time in the oven (min)
FRUIT					
Strawberries	2	160-180	30-45	/	20-30
Stone fruits	2	160-180	30-45	/	20-30
Fruit mush	2	160-180	30-45	/	20-30
VEGETABLES					
Pickled gherkins	2	160-180	30-45	/	20-30
Beans/carrots	2	160-180	30-45	120°C, 45-60 min	20-30



TOP AND BOTTOM HEATER WITH FAN

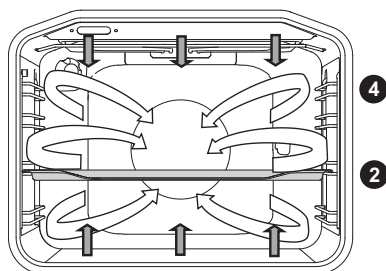

It is used for baking of all types of pastry, for defrosting, and for drying fruit and vegetables. Before placing the food into the preheated oven, wait for the light to go off for the first time. For best results, only bake on one shelf (level).

The oven should be preheated. Use the second or the fourth guide, counting from the bottom up.

Table for baking pastry with upper and lower heater and the fan

Type of pastry	Guide level (from the bottom)	Temperature (°C)	Cooking time (minutes)
Marble cake	2	140-150	45-55
Cake in a rectangular baking sheet	2	130-140	45-55
Cheesecake	2	130-140	55-65
Fruit cake - shortcrust	2	140-150	35-45
Sponge cake	2	140-150	25-35
Fruit cake, sponge	2	130-140	35-45
Sponge roll	2	140-150	15-25
Christmas loaf	2	130-140	50-60
Jelly-filled rolls (Buchtel)	2	150-160	25-35
Gugelhupf (Bundt cake)	2	130-140	40-50
Shortcrust biscuits	2	140-150	15-25
Pressed cookies *	2	130-140	10-15
Small pastries, leavened dough	2	140-150	15-20
Bread*	2	170-180	45-55
Quiche Lorraine	2	150-160	35-45
Apple strudel	2	150-160	40-50
Pizza*	2	180-190	10-20
Phyllo pastry	2	150-160	18-25

The symbol * means that the oven should be preheated using the selected cooking system.

GENTLE BAKE

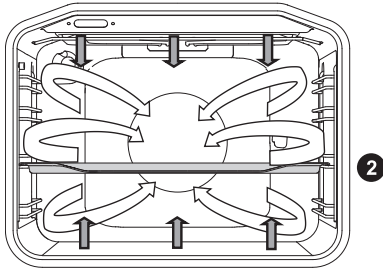

This feature allows gentle, slow, and even baking that leaves the food soft and juicy. It is suitable for roasting meat, cooking fish, and baking pastry on a single rack.

Type of food	Guide (from the bottom)	Temperature (°C)	Cooking time (minutes)
MEAT			
Pork roast, 1 kg	2	190	90 - 120
Beef roast, 1 kg	2	190	100-130
Beef tenderloin, 200 g/piece	2	180	40-50
Chicken, 1,5 kg	2	210	100 - 120
Chicken breast, fillet, 200 g/piece	2	200	45 - 60
Veal roast, 1 kg	2	180	95 - 120
FISH			
Whole fish, 200 g/piece	2	190	35 - 45
Fish fillet, 100 g/piece	2	190	25 - 35
PASTRY			
Shortcrust biscuits	2	150	25-40
Piped cookies	2	150	35-50
Small cupcakes	2	170	35-50
Sponge roll	2	170	40-55
Fruit cake, shortcrust	2	170	65-85

DEFROSTING



In this mode, the air will circulate without any heaters operating.

Food suitable for defrosting includes cakes with heavy cream or butter-based cream, cakes and pastry, bread and rolls, and deep-frozen fruit.

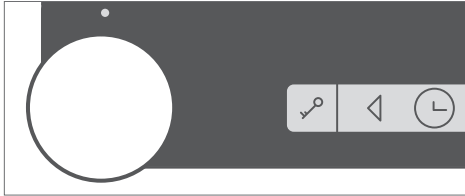

Turn the COOKING SYSTEM SELECTOR KNOB to defrosting.

Touch the START/STOP key to start the defrosting process.

In most cases, it is recommended to remove the food from the packaging (do not forget to remove any metal clamps or clips).

Halfway through the defrost time, the pieces should be turned over, stirred and separated if they were frozen together.

MAINTENANCE & CLEANING



Be sure to unplug the appliance from the power supply and wait for the appliance to cool down.

Children should not clean the appliance or perform maintenance tasks without proper supervision.

Aluminium finish

Clean the aluminium finish with non-abrasive liquid cleaners intended for such surfaces. Apply the cleaner onto a wet cloth and clean the surface. Then, rinse the surface with water. Do not apply the cleaner directly onto the aluminium finish.

Do not use abrasive cleaners or sponges.

Note: The surface should not come into contact with oven cleaning sprays as this may result in visible and permanent damage.

Stainless steel sheet front side of the housing

(depending on the model)

Clean this surface only with a mild detergent (soapsuds) and a soft sponge that will not scratch the finish. Do not use abrasive cleaners or cleaners containing solvents as they may damage the housing finish.

Lacquer-coated surfaces and plastic parts

(depending on the model)

Do not clean the knobs and buttons, door handles, stickers, and rating/type plates with abrasive cleaners or abrasive cleaning materials, alcohol-based cleaners, or with alcohol. Immediately remove any stains with a soft non-abrasive cloth and some water, in order to avoid damaging the surface.

You may also use cleaners and cleaning materials intended for such surfaces as instructed by their respective manufacturers.

Control unit

Do not clean the surface with abrasive cleaners or harsh cleaning tools.



The aluminium-coated surfaces should not come into contact with oven cleaning sprays as this may result in visible and permanent damage.

CONVENTIONAL OVEN CLEANING

You may use the standard cleaning procedure to clean stubborn dirt in the oven (using cleaners or an oven spray). After such cleaning, rinse the cleaner residues thoroughly.

Clean the oven and the accessories after each use to prevent the dirt from burning into the surface. The easiest way to remove fat is by using warm soapsuds while the oven is still warm.

With stubborn dirt and grime, use conventional oven cleaners. Rinse the oven thoroughly with clean water to remove all cleaner residue.

Never use aggressive cleaners, abrasive cleaners, abrasive sponges, stain and rust removers etc.

Clean the accessories (baking sheets and trays, grids etc.) with hot water and detergent.

The oven, the oven cavity and the baking trays are lined with a special enamel coating for a smooth and resistant surface. This special coating makes cleaning at room temperature easier.

USING THE STEAM CLEAN FUNCTION TO CLEAN THE OVEN

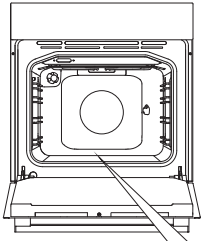

1 Turn the COOKING SYSTEM SELECTOR KNOB to Steam Clean. 2. Set the TEMPERATURE KNOB to 70 °C.

.....

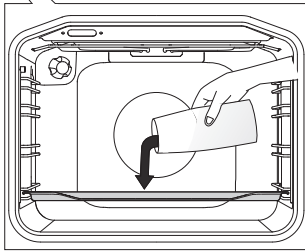

2 Pour 0.6 l of water into a glass or shallow baking dish and insert it into the lower guide.

.....

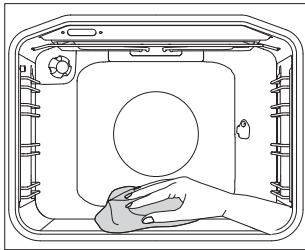

3 After 30 minutes, food residues on the oven enamel walls will have softened and they will be easy to clean with a damp cloth.



Use the steam clean system when the oven has fully cooled down.

REMOVING AND CLEANING WIRE AND TELESCOPIC EXTENDABLE GUIDES

Only use conventional cleaners to clean the guides.

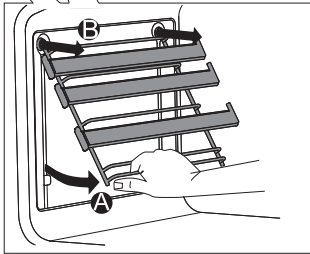
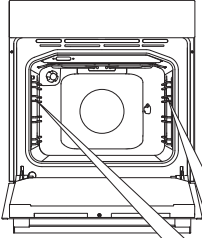

A Hold the guides by the bottom side and pull them towards the center of the oven cavity.

B Remove them from the openings at the top.

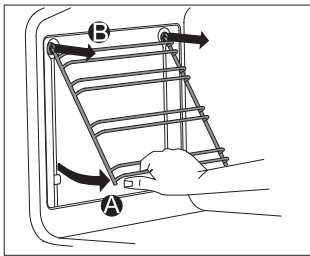

Do not clean the extendable guides in the dishwasher.

INSTALLING THE CATALYTIC INSERTS

Only use conventional cleaners to clean the guides.

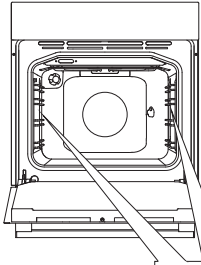

Remove the wire guides or extendable guides.

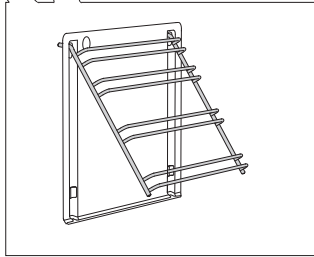

1 Mount the guides onto the catalytic insert.

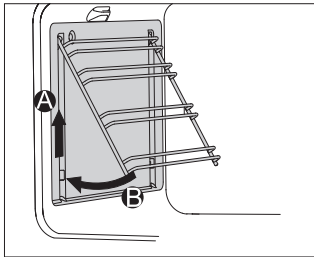

2 Hang the inserts with guides attached using the holes provided, and pull upwards.

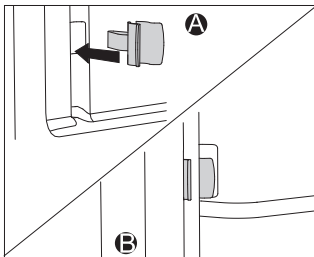

When installing fully extendable guides with catalytic inserts, insert one end of the supplied snap locks into the openings at the bottom of the oven cavity wall and insert the other end of the snap locks into the guides.

The purpose of the snap locks is to hold the guides in place more firmly.



Do not wash the catalytic inserts in the dishwasher.

REMOVING AND INSERTING THE OVEN DOOR

(depending on the model)

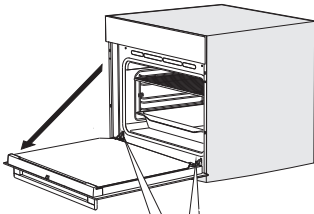

1 First, fully open the door (as far as it will go).

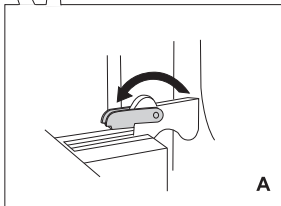

2 **A** Rotate the stoppers all the way back (in case of conventional closing).

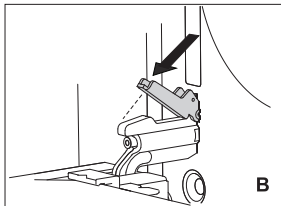

B If the appliance is fitted with the Soft Close system, flip the door latches back to a 90° angle (Figure 2).

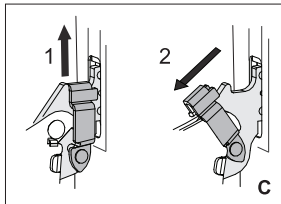

C If the appliance is fitted with the Soft Close system, slightly lift the door latches and pull them towards you.

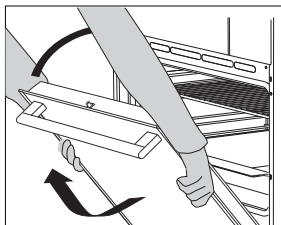

3 Slowly close the door until the latches are aligned with the slots. Slightly lift the door and pull it out from both hinge slots on the appliance.

To replace the door, observe the reverse order. If the door does not open or close properly, make sure the notches on the hinges are aligned with the hinge beds.



When replacing the door, always make sure the hinge retainers are correctly placed in the hinge beds to prevent sudden closing of the main hinge which is connected to a strong main spring. If the main spring is engaged, there is a risk of injury.

DOOR LOCK (depending on the model)

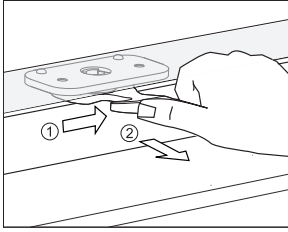

To open it, gently push it to the right with your thumb and pull the door outwards at the same time.

 **When the oven door is closed, the door lock automatically returns to the initial position.**

DEACTIVATING AND ACTIVATING THE DOOR LOCK

 **The oven should be cooled down completely.**

First, open the oven door.

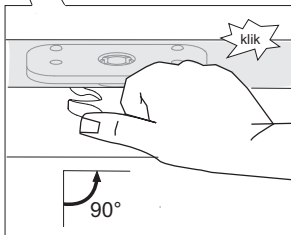
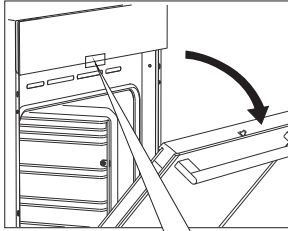

Push the door lock to the right by 90° with your thumb until you feel a click. The door lock is not deactivated.

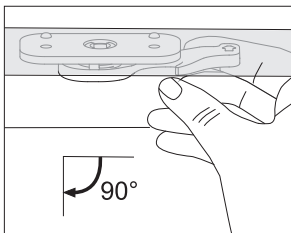

To reactivate the door lock, open the oven door and use your right-hand index finger to pull the lever towards you.

SOFT CLOSE (depending on the model)

Oven door is fitted with a system that dampens the door closing force, starting at the 75-degree angle. It allows simple, quiet, and smooth closing of the door. A gentle push (to a 15-degree angle relative to the closed door position) is enough for the door to close automatically and softly.



If the force applied to close the door is too strong, the effect of the system is reduced or the system will be bypassed for safety.

REMOVING AND INSERTING THE OVEN DOOR GLASS PANE

Oven door glass pane can be cleaned from the inside, but it has to be removed first. Remove the oven door (see chapter "Removing and replacing the oven door").

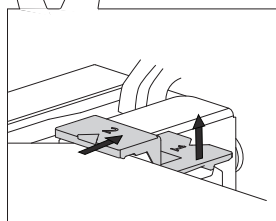
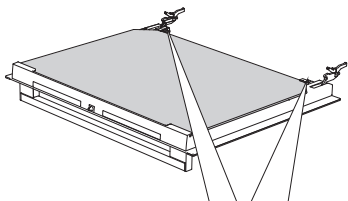

1 Slightly lift the supports on the left and right side of the door (marking 1 on the support) and pull them away from the glass pane (marking 2 on the support).

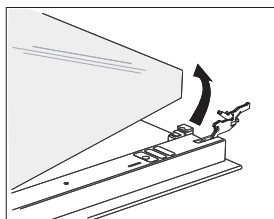

2 Hold the door glass pane by the lower edge; slightly lift it so that it is no longer attached to the support; and remove it.

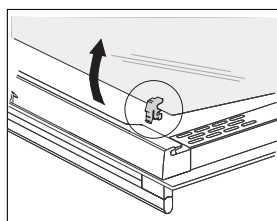

3 To remove the third glass pane (only with some models), lift and remove it. Also remove the rubber seals on the glass pane.



To replace the glass pane, observe the reverse order. The markings (semi-circle) on the door and the glass pane should overlap.

REPLACING THE BULB

The bulb is a consumable and therefore not covered by warranty. Before changing the bulb, remove the trays, the grid, and the guides.

(Halogen lamp: G9, 230 V, 25 W; regular bulb E14 25W 230V)

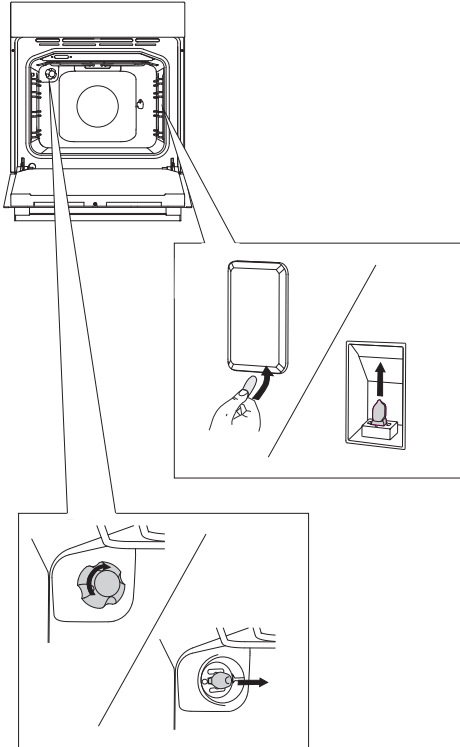

Use a flat screwdriver to release the bulb cover and remove it. Remove the bulb.

💡 Be careful not to damage the enamel.

.....

Undo the bulb cover and remove the bulb.

💡 Use protection to avoid burs.

TROUBLESHOOTING TABLE

Problem/error	Cause
There is no response of the sensors; the display is frozen.	Disconnect the appliance from the power mains for a few minutes (undo the fuse or switch off the main switch); then, reconnect the appliance and switch it on.
The main fuse in your home trips often.	Call a service technician.
The oven lighting does not work.	The process of changing the light bulb is described in the chapter Cleaning and Maintenance.
The pastry is underdone.	Did you choose the right temperature and heating system? Is the oven door closed?
An error code is displayed (E1, E2, E3 etc.).	<ul style="list-style-type: none">• There is an error in the electronic module operation. Disconnect the appliance from the power mains for a few minutes. Then, reconnect it and set the time of day.• If the error is still indicated, call a service technician.

If the problems persist despite observing the advice above, call an authorised service technician. Repair or any warranty claim resulting from incorrect connection or use of the appliance shall not be covered by the warranty. In this case, the user will cover the cost of repair.



Before the repair, disconnect the appliance from the power mains (by removing the fuse or by removing the plug from the wall outlet).

DISPOSAL



Packaging is made of environmentally friendly materials that can be recycled, disposed of, or destroyed without any hazard to the environment. To this end, packaging materials are labelled appropriately.

The symbol on the product or its packaging indicates that the product should not be treated as normal household waste. The product should be taken to an authorized collection center for waste electric and electronic equipment processing.

Correct disposal of the product will help prevent any negative effects on the environment and health of people which could occur in case of incorrect product removal. For detailed information on removal and processing of the product, please contact the relevant municipal body in charge of waste management, your waste disposal service, or the store where you bought the product.

We reserve the right to any changes and errors in the instructions for use.

