

Hisense

life reimagined

EN

User manual

Dishwasher

HV673C60UK

Contents

Your dishwasher	4
Safety instructions	5
Installation	6
Overflow guard function	6
Winter storage/transport	6
Packaging	6
Disposal	6
Before washing for the first time	7
Water hardness	7
Basic settings	8
Top up with rinse aid	8
Top up with salt	8
Greener dishwashing	9
Save energy and water	9
Loading the dishwasher	10
Fragile dishes	10
Loading affects the results	10
The dishwasher's baskets	10
Top cutlery tray	10
Upper basket	11
Lower basket	12
Using the dishwasher	13
Add detergent	13
On/Off	14
Select program	14
Select option	15
Start/Stop	16
Status Light	16
If you want to load more dishes	17
Power failure	17
Once the program has finished	17
The best drying results	17
Unloading the dishwasher	17
Program chart	18
WiFi connection	19
ConnectLife	19
Preparations	19
Connect to a network and pair	19
Remote control the dishwasher	20
Remote start the dishwasher	20
Pair more devices	20
Deactivate/activate WiFi connection	20
Remove devices	20
Settings	21

Care and cleaning	23
Top up with rinse aid	23
Top up with salt	23
Clean the filters	24
Cleaning the spray arms	25
Clean the outside of the dishwasher	26
CLn - Run the Clean (Self-clean) program	26
Remove blockages	26
Troubleshooting	28
General	28
WiFi	33
Installation	34
Safety instructions	34
Setup	34
Drainage connection	35
Connection to water supply	35
Electrical connection	35
Service	37
Technical data and energy labelling	38
Technical data	38
Information for consumers	38
Information for test institute	38
EU declaration of conformity	38

Your dishwasher

Install the dishwasher, see the chapter *Installation*. Then open the door and press ①.

The first time the dishwasher is switched on, it is important that you choose the right settings to ensure good dishwashing results. See the chapter *Before washing for the first time*.

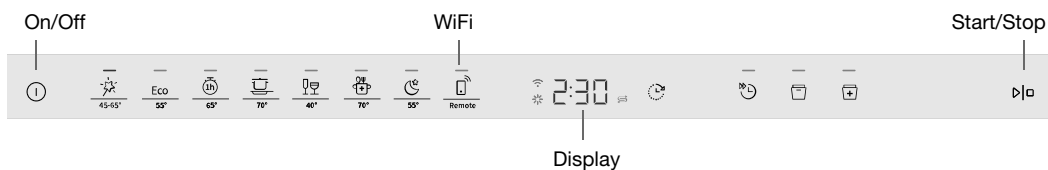

Program

 Auto 45-65°

Eco Eco 55°

 1h 65°

 Intensive 70°

 Glass 40°

 Hygiene 70°

 Night 55°

 Remote (WiFi)

Option

 Delayed start

 Speed wash

 Auto Dry

Special program

 Self-clean

Information on the display

See the chapter *Care and cleaning*.

 Connected to the cloud (Flashes when connecting)

 Top up with rinse aid

 Top up with salt

CLn Run the Clean (Self-clean) program

NOTE!

The control panel only reacts to use when the door is open.

Safety instructions

- Read the operating instructions and keep them in a safe place!
- Number of standard place settings: 16
- Never use the dishwasher for any purpose other than that specified in these operating instructions.
- Do not load the dishwasher door or dishwasher baskets with anything other than dishes.
- Never leave the dishwasher door open as someone may trip on it. Push the baskets in to avoid risking the dishwasher tipping over.
- Use only dishwasher detergent!
- This machine can be used by children aged 8 and upwards, and by people with reduced physical capacity, mental ability, memory loss or lacking experience and knowledge. These individuals must be supervised when using the machine or have instructions on how to use the machine and understand the risks that can occur. Cleaning of the machine must not be carried out by children without supervision.
- Damaged supply cord must only be replaced by the manufacturer's service centre or someone similarly professionally qualified.
- Only use the dishwasher in household-type environments for dishwashing household dishes. All other use is prohibited.
- Never place dishes with solvent residues in the dishwasher due to the risk of explosion. Nor may dishes that contain ash, wax or lubricants be washed in the dishwasher.
- Children must be watched. Do not allow children to use or play with the dishwasher. Be especially vigilant when the door is open. Some detergent may remain inside! After adding detergent, always start the dishwasher immediately.



WARNING!

Knives and other pointed items must be placed horizontally in the dishwasher's special cutlery baskets.

**WARNING!**

Children must be supervised – dishwasher detergent is corrosive!

Installation

See the chapter *Installation*.

Overflow guard function

The overflow guard starts pumping out the machine and turns off the water supply if the water level in the dishwasher exceeds the normal level. If the overflow guard is triggered, F54 (Overfilling water) appears on the display. Turn off the water tap and contact your nearest service centre. (To avoid water leakage outside the dishwasher, do not remove the plug from the wall socket until the water tap on the supply line has been turned off!)

Winter storage/transport

Store the dishwasher above freezing and avoid long transport distances in very cold weather. Transport the dishwasher upright or laying on its back.

Before transporting a used dishwasher, or before prolonged storage, water must first be removed from the machine.

Packaging

The outer packaging protects the product during transport. The packaging material is recyclable. Separate the different packaging materials to help reduce raw material use and waste. Your dealer can take the packaging for recycling or direct you to the nearest recycling centre. The packaging is comprised of:

- Corrugated cardboard made from up to 100% recycled material.
- Expanded polystyrene (EPS) with no added chlorine or fluorine.
- Supports made from untreated wood.
- Protective plastic made from polyethylene (PE).

Disposal

The dishwasher is manufactured and labelled for recycling. When the dishwasher has reached the end of its service life and is to be disposed of, it should immediately be made unusable. Pull out the power cable and cut it as short as possible.

Contact your local authority for information about where and how your dishwasher should be correctly recycled.

Before washing for the first time

Water hardness

In order to achieve good dishwashing results, the dishwasher needs soft water (water with low mineral content). Hard water leaves a white coating on dishes and the dishwasher.

Checking water hardness

Water hardness is specified using German degrees of water hardness (°dH), French degrees of water hardness (°fH), English degrees of water hardness (°eH) or millimoles per litre (mmol/l).

A water supply with a water hardness in excess of 5°dH (9°fH / 6°eH / 0.9 mmol/l) must be softened. This is done automatically with the aid of the built-in water softener. In order for the water softener to function properly, its settings must be adjusted to the hardness of the water supply. Once you have adjusted the water softener settings, add detergent and rinse aid in doses suitable for soft water.

Contact the local waterworks to check the water hardness in your area.

Make a note of the water hardness: _____

°dH	°fH	°eH	mmol/l	Recommended setting
0-5	0-9	0-6	0.0-0.9	00
6-8	10-14	7-10	1.0-1.4	01
9-11	15-20	11-14	1.5-2.0	02
12-14	21-25	15-18	2.1-2.5	03
15-19	26-34	19-24	2.6-3.4	04
20-24	35-43	25-30	3.5-4.3	05
25-29	44-52	31-36	4.4-5.2	06
30-39	53-70	37-49	5.3-7.0	07
40-49	71-88	50-61	7.1-8.8	08
50	89	62	8.9	09

If the water hardness exceeds 50°dH (89°fH / 62°eH / 8.9 mmol/l), we recommend connecting an external water softener.

Increased consumption during regeneration

The dishwasher's built-in water softener is regularly regenerated to maintain its function. Regeneration extends the dishwashing program and increases energy and water consumption. Just how often the dishwasher's water softener is regenerated depends on the selected setting.

Example: If the Eco 55° program is run with a water hardness of 14°dH (25°fH / 18°eH / 2.5 mmol/l), the water softener is regenerated at regular intervals (after 7 dishwashing cycles), energy consumption increases by 0.015 kWh, and water consumption increases by 2.3 litres, while the program time is extended by 3 minutes. Regeneration takes place during the program's main wash.

WARNING!

Hard water leaves a white coating on dishes and inside the dishwasher. It is therefore important that you select the right setting for the water softener! See Water hardness in the chapter *Settings*.

Never run the dishwasher with an empty salt compartment if the water supply has a water hardness in excess of 5°dH (9°fH / 6°eH / 0.9 mmol/l).

Basic settings

The first time the dishwasher is switched on, it is important that you choose the right settings to ensure good dishwashing results. See the chapter *Settings*.

Set up:

- Rinse aid
- Water hardness
- TAB

✨ Top up with rinse aid

Drying is faster and a better result is achieved if you use rinse aid. You will also achieve a better dishwashing result with clear and spotless dishes.

Top up the rinse aid compartment with rinse aid if you have selected Rinse aid 01 - 05.

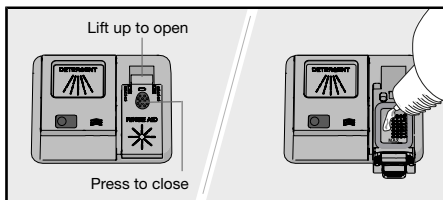

1. Open the rinse aid compartment lid.
2. Carefully top up with rinse aid to the level marked **MAX**.
3. Wipe up any splashes of rinse aid around the compartment.
4. Close the lid firmly.

☞ Top up with salt

Add salt to the salt compartment if you have selected Water hardness 01 - 09.

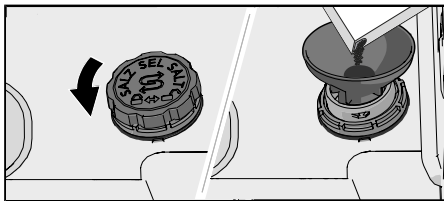

1. Remove the salt compartment lid by turning it anticlockwise.
2. Place the funnel supplied with the dishwasher in the salt compartment top-up hole. First, pour in about 1 l of water.
3. Add enough salt to fill the salt compartment (max. 750 gram). Use special dishwasher salt.
4. Wipe up any excess salt so that the lid can be screwed on firmly.

⚠ WARNING!

In order to avoid rust stains a dishwashing program must be started immediately after adding salt.

Greener dishwashing

Save energy and water

When using a dishwasher in a residential setting, less energy and water are generally used compared to washing the dishes by hand.

Do not rinse under running water



Do not rinse the dishes under running water as this will lead to increased energy and water consumption. Simply scrape off large food particles before loading the dishwasher.

Choose a green detergent

Read the environmental declaration on the packaging!

Too much detergent, rinse aid and salt can result in less effective dishwashing and also entail greater environmental impact.

Run a fully loaded dishwasher

Save energy and water by waiting until the dishwasher is full before running a program (see number of standard place settings). Use the  1h 65° program with the  Speed wash option to rinse the dishes if there are any unpleasant odours.

Run programs at a lower temperature

If the dishes are only slightly dirty, you can select a program with a low temperature.

Select dishwashing program – Eco 55°

This program is suitable for washing normally soiled dishes and is the most effective program in terms of combined energy and water consumption. This program is used to assess compliance with EU legislation on ecodesign.

The dishwashing program is designed for an effective wash using as little energy and water as possible. The program washes at a low temperature for a long time.

Select option – Auto Dry

A shorter dishwashing program and better drying results are achieved if you use the  Auto Dry option, which automatically opens the dishwasher door. Wait until the dishwasher indicates that the program has ended and the dishes have cooled before unloading the dishwasher. (If the dishwasher is built-in, the surrounding furnishings must be resistant to any condensation from the dishwasher.)

Connect to cold water

Connect the dishwasher to the cold water supply if the building is heated using oil, electricity or gas.

Connection to hot water supply

Connect the dishwasher to the hot water supply (max. 70 °C) if the building is heated using an energy-efficient means such as district heating, solar power or geothermal power. Choosing a hot water connection reduces the dishwasher's energy consumption.

NOTE!

Do not exceed the permitted water supply temperature. Certain materials used in some cookware cannot withstand high heat. See *Fragile dishes* in the chapter *Loading the dishwasher*.

Loading the dishwasher

Fragile dishes

Some cookware is not dishwasher safe. This can be for several reasons. Some materials cannot withstand high heat, others can be damaged by dishwasher detergent.

Exercise caution with, for example, handmade items, fragile decoration, crystal/glassware, silver, copper, tin, aluminium, wood and plastic. Look for the "Dishwasher safe" marking.

Loading affects the results

Load the dishes carefully to ensure the best washing and drying results with the lowest possible energy and water consumption. Give your dishwasher the best chance to reach and clean all surfaces, as well as to dry the dishes as thoroughly as possible.

- All dirty surfaces should face inwards and downwards!
- Dishes should not be placed in or on each other.
- Angle dishes with hollows, such as cups, so that the rinse water will run off. This is also important for plastic items.
- Make sure small items cannot fall through the dishwasher basket; place them in the top cutlery tray.



NOTE!

Check that the spray arms can rotate freely.

The dishwasher's baskets

The dishwasher is equipped with a top cutlery tray, an upper basket and a lower basket.

The appearance of the baskets may differ depending on the dishwasher setup.

Top cutlery tray

The top cutlery tray has space for cutlery, ladles, whisks, serving cutlery and similar items.

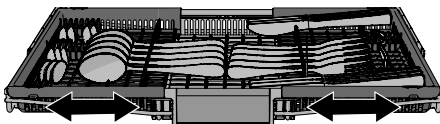
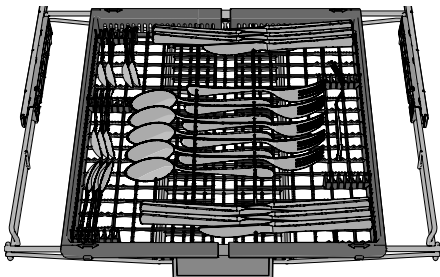

The top cutlery tray is comprised of three parts that can be moved sideways to better accommodate the dishes.

Upper basket

Place glasses, cups, bowls, side plates and saucers in the upper basket. All dirty surfaces should face inwards and downwards! Wine glasses are placed on the wine glass shelf and knives are placed in the knife stand on the right.

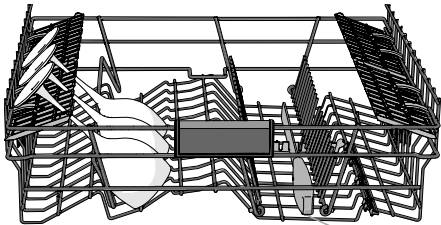
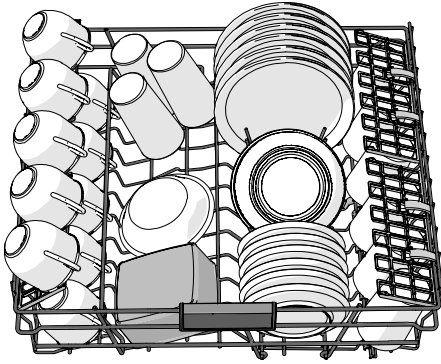

Knife stand

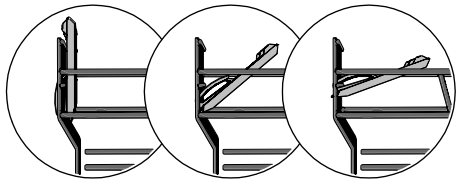

3 positions

Raising and lowering the upper basket

1. Pull out the upper basket.
2. Grab the sides of the upper basket with both hands and lift it up.
3. If the upper basket is raised while in the top position, it will drop to the bottom position.
Note that both sides of the basket must always be set to the same height.

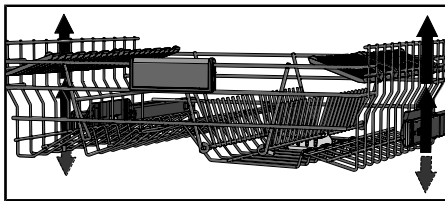

Adjustable plate supports

The adjustable plate supports can be folded down to make it easier to load pots, bowls and glasses.

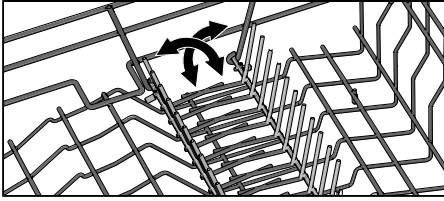

Lower basket

Place plates, side plates, serving dishes and pots in the lower basket. Cutlery can be placed in the cutlery holder.

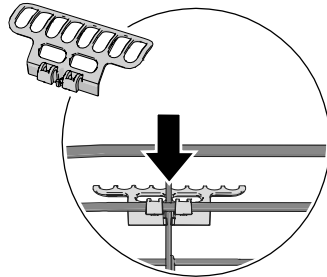
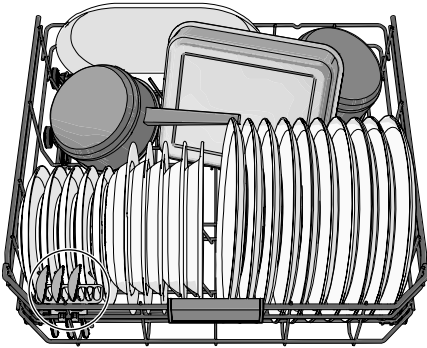

Fit the cutlery holder to achieve maximum loading capacity. (Found inside the enclosed plastic bag.)

Adjustable plate supports

The adjustable plate supports can be folded down to make it easier to load pots and bowls.

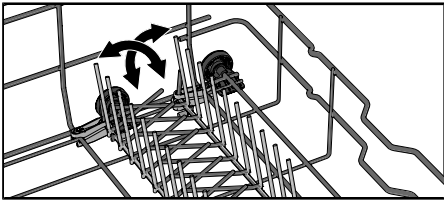

Using the dishwasher

Add detergent

Follow the instructions on the detergent packaging. This dishwasher is fitted with a water softener, so use detergent and rinse aid doses suitable for soft water.

Too much detergent can result in less effective dishwashing and also entails greater environmental impact.

Detergent compartment

The detergent compartment must be dry when adding detergent.

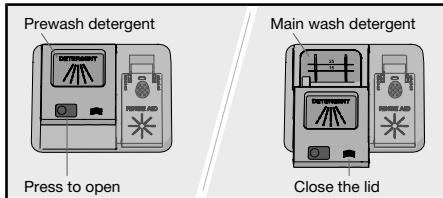

If powder or liquid dishwasher detergent is used, add a small amount of the detergent to the compartment for prewash detergent.

NOTE!

Use only dishwasher detergent! Washing up liquid must not be used as the foam that forms prevents the dishwasher from operating effectively.

All-in-one detergent

There are many types of all-in-one detergents on the market. Read through the directions for these products carefully.

Activate the TAB setting and deactivate the Rinse aid setting, when using an all-in-one detergent that contains rinse aid.

Dishwasher tablets are not recommended for short programs (less than 75 minutes). Use powder or liquid dishwasher detergent instead.

NOTE!

Optimal washing and drying results are achieved by using normal detergent together with separately dispensed rinse aid and salt.

Contact the detergent manufacturer if you have questions about the detergent.

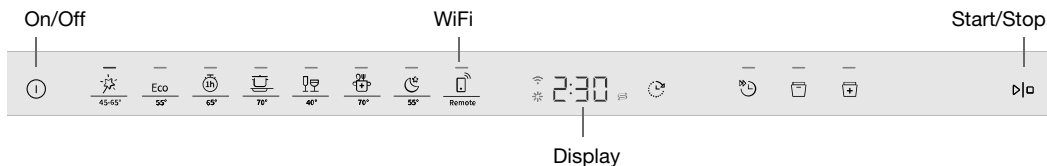

NOTE!

The control panel only reacts to use when the door is open.

① On/Off

Open the door and press ①. Also turn on the water tap if it is turned off.

Select program

Select a program to suit the type of dishes and how dirty they are. Eco 55° is always pre-selected.

Press the desired program until it is activated, which is indicated by an indicator light.



Auto 45-65°

The dishwasher can measure how dirty the dishes are and adjust water consumption and temperature accordingly. When newly installed, the program needs to be run five times before it is fully adapted and can provide the best results.

ECO Eco 55°

This program is suitable for washing normally soiled dishes and is the most effective program in terms of combined energy and water consumption. This program is used to assess compliance with EU legislation on ecodesign.

You can read more about greener dishwashing in the chapter *Greener dishwashing*.

For heavily soiled dishes with a lot of grease, a program with higher temperatures should be used.



1h 65°

A quick program for slightly dried leftovers. (This program is not intended for burnt food, such as on oven dishes.)

The Auto Dry option is important for ensuring the best drying results.



Intensive 70°

A program with a high temperature for dissolving grease on very dirty dishes, such as pans, casserole dishes and oven dishes. If these dishes do not completely fill the dishwasher, you can add plates and other dishes.



Glass 40°

A gentle dishwashing program with a low temperature for washing fragile items made of crystal/glass. Remember to use a small amount of detergent and to place items so that they do not touch each other during the wash. See also *Fragile dishes* in the chapter *Loading the dishwasher*. Porcelain that has just been used without dried leftovers can also be washed using this program.



Hygiene 70°

This program is ideal to use where demands on hygiene are extra high, e.g. for baby bottles and cutting boards. The temperature is high both in the main wash and in the final rinse.





Night 55°

A quieter dishwashing program, suitable for running at night. The program time is extended.



Remote (WiFi)

You can remote control this dishwasher with your smartphone/tablet. Connect the dishwasher to your wireless network to be able to remote control and start the dishwasher using the *ConnectLife* app. See the chapter *WiFi connection*.

To remote start the dishwasher, press  and then . APP will flash on the dishwasher's display. Close the door. The status light will flash slowly, indicating that remote start is activated.

In the *ConnectLife* app, select and start a program.

If the door is not closed within 2 minutes, the machine switches off.



Clean (Self-clean)

Self-cleaning program for hygienic cleaning of the dishwasher tub, spray arms and spray pipes.

This program should be run (with no dishes in the machine) using normal dishwasher detergent or citric acid. Special dishwasher cleaners are also available on the market. For the removal of limescale deposits, see *Dishwasher tub* in the chapter *Care and cleaning*.

The dishwasher will indicate at regular intervals that Self-clean needs to be run.



Select option

Press the options to activate them. (The available options vary between programs.)



Delayed start

When you select Delayed start, the dishwasher will start 1-24 hours after you have pressed  and closed the door.

1. Press  once to activate Delayed start. Press several times, or hold it in, to set the desired number of hours. The time for Delayed start is shown on the display.
2. Press . Close the door. The timer counts down and the dishwasher starts after the selected delay.

If you want to cancel the Delayed start option, open the door then press and hold  for three seconds.

Not available for: Self-clean



Speed wash

This option shortens the program time, but uses more energy and water.

Press  to activate the option. The program time is updated on the display.

Not available for: Auto 45-65°, Glass 40°, Hygiene 70°, Self-clean

Auto Dry

The dishwasher door opens automatically, which shortens the program time and improves the drying results. Wait until the dishwasher indicates that the program has ended and the dishes have cooled before unloading the dishwasher. (If the dishwasher is built-in the surrounding furnishings must be resistant to any condensation from the dishwasher.)

The drying time of the Auto Dry option varies (from 5 to 90 minutes) depending on the model, program and temperature of the final rinse.

Press  to activate the option, which is indicated by an indicator light.

The Auto Dry option is pre-selected for some programs.

Not available for: Hygiene 70°, Self-clean

NOTE!

For the best drying results, do not close the door before the drying phase has finished and the machine has automatically switched off.

WARNING!

The dishwasher door must not be blocked or closed when opened automatically. Doing so may damage the door lock mechanism. Wait at least 5 minutes before closing the door.

Start/Stop

Press . The display will start to flash, indicating that the dishwasher is ready to start. Close the door properly, otherwise the dishwasher will not start.

To remote start the dishwasher, see the chapter *WiFi connection*.

Stopping or changing a program

Open the door. If you want to interrupt or change the program after starting the dishwasher, press and hold  for three seconds.

Top up with new detergent if the lid of the detergent dispenser has opened. Then select a new program, press  and close the door.

Remaining time

Once you have chosen a program and options, the time the program took when last used is displayed.

Status Light

The status light on the bottom part of the dishwasher indicates that a program has started.

Flashing light

A flashing light indicates that the door has been opened while a program is in progress. If it flashes when the door is closed, an error has occurred. See the chapter *Troubleshooting*.

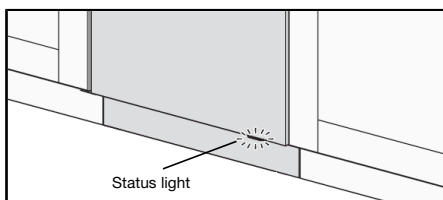

If you want to load more dishes¹⁾

Open the door. The dishwasher stops automatically. Add the dishes and close the door. After a while, the dishwasher continues the program.

If the dishwashing program was remote started, the interrupted program will continue once the door is closed. You can monitor the dishwasher using the *ConnectLife* app and remote stop the program, although you will not be able to remote start it again.

Power failure

If the dishwasher is turned off due to a power failure when a dishwashing program is running, the program continues when power is restored. If the power is cut during drying, the program is interrupted.

If the dishwashing program was remote started and has not ended, the program will continue once the power is restored. You can monitor the dishwasher using the *ConnectLife* app and remote stop the program, although you will not be able to remote start it again.

If the door is open for more than 2 minutes during drying, the program is interrupted.

Once the program has finished

The end of the program is indicated by one short signal from the buzzer. The chapter *Settings* describes how to change this function.

Moreover, the end of the program is indicated by the status light turning off.

Once the dishwasher door is opened and the program has finished "End" appears on the display.

The dishwasher switches off automatically after the program ends. Shut off the water tap after each use.

The best drying results

- Fully load the dishwasher.
- Angle dishes with hollows, such as cups, so that the rinse water will run off. This is also important for plastic items.
- Top up with rinse aid or increase the rinse aid dosage setting.
- Activate the  Auto Dry option.
- Open the door a little once the program has finished.
- Allow the dishes to cool before unloading the dishwasher.







Unloading the dishwasher

Hot porcelain is more fragile. Leave the dishes to cool in the dishwasher before unloading them.

Unload the lower basket first to avoid any water drops from the upper basket falling onto the dishes in the lower basket.

¹⁾ You should not load more dishes if the lid of the detergent dispenser has been opened.

Program chart

Program	Detergent (ml)	Option	Number of pre-washes	Main wash	Number of rinses	Final rinse	Consumption values ¹⁾		
							Dishwashing time (approx. hrs:min)	Energy (approx. kWh)	Water cons. (liter)
 Auto 45-65°	25	Auto Dry	1-2	45-65 °C	2-3	60 °C	2:10-3:10	0.9-1.4	11.5-19.0
Eco Eco 55° ²⁾	25	Auto Dry		55 °C	2	47 °C	3:20	0.76	9.6
 1h 65°	25	Auto Dry		65 °C	3	65 °C	1:00	1.1	15.0
 Intensive 70°	25		2	70 °C	2	70 °C	2:50	1.6	16.0
 Glass 40°	20			40 °C	2	50 °C	1:40	0.7	10.0
 Night 55°	25		1	55 °C	2	65 °C	5:35	1.4	14.0
 Hygiene 70°	25			70 °C	2	70 °C	1:05	1.3	11.0

¹⁾ Consumption values vary depending on the temperature of the incoming water, room temperature, load size, selected additional functions and more. The values for the Eco 55° program are accurate, others are indicative only.

²⁾ This program is suitable for washing normally soiled dishes and is the most effective program in terms of combined energy and water consumption. This program is used to assess compliance with EU legislation on ecodesign.

WiFi connection

ConnectLife

You can remote control this dishwasher with your smartphone/tablet. Connect the dishwasher to your wireless network to be able to remote control and start the dishwasher using the *ConnectLife* app. The app can be used to find information, change settings, start a program and monitor the dishwasher. (The dishwasher can always be used without the app.)

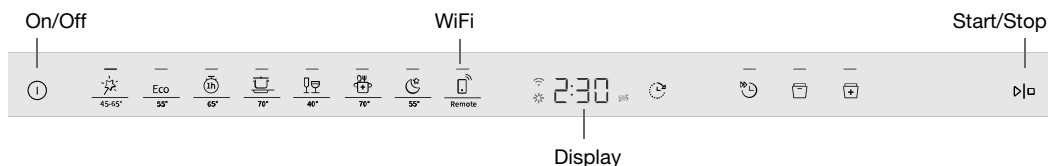

Preparations

- Your smartphone/tablet must be connected to the internet.
- The router in your wireless network must be connected to the internet and the dishwasher must be in range of your wireless network.
- Use your smartphone/tablet to download the *ConnectLife* app from the appropriate app store or scan the QR code below.



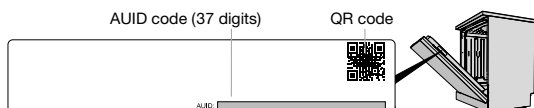

- You will find the dishwasher's QR code (and the AUID code) on the serial number plate.



Connect to a network and pair

Connect the dishwasher to your wireless network and pair with your smartphone/tablet.

- Open the *ConnectLife* app and register an account.
- Go to *Appliances*. Click on *Add appliances* or the + button. Select *Home appliances*.
- Scan the dishwasher's QR code (see the serial number plate). Follow the further instructions in the app.
- Open the dishwasher door and press .
- On the dishwasher's control panel: Press and hold  for 2 seconds to start connecting. C appears on the display, after which the display starts counting down.

Network symbol on the display

Flashing 0.5 sec on/off

The dishwasher is ready to be connected to your wireless network or paired with your smartphone/tablet.

Flashing 1.0 sec on/off

The dishwasher is connected to your wireless network.



Glow

The dishwasher is connected to your wireless network and the cloud.

Remote control the dishwasher

The dishwasher's network symbol  is shown on the display when the dishwasher is paired with a smartphone/tablet. You can use the *ConnectLife* app to monitor the dishwasher and change settings.

Remote start the dishwasher

To remote start the dishwasher, press  and then . APP will flash on the dishwasher's display. Close the door. The status light will flash slowly, indicating that remote start is activated.

In the *ConnectLife* app, select and start a program.

If the door is not closed within 2 minutes, the machine switches off.

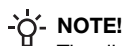



NOTE!

The dishwasher can always be used without the app. When the dishwasher's control panel is pressed, commands from the *ConnectLife* app are blocked for 10 seconds.



Pair more devices

Pair more devices/users with the dishwasher.

- Open the *ConnectLife* app and log in to your account or register a new account.
- Go to *Appliances*. Click on *Add appliances* or the + button. Select *Home appliances*.
- Scan the dishwasher's QR code (see the serial number plate). Follow the further instructions in the app.
- Open the dishwasher door and press .
- On the dishwasher's control panel: Press and hold  for 4 seconds to start connecting. P appears on the display, after which the display starts counting down.



Deactivate/activate WiFi connection

After connecting the dishwasher to your local network, you can deactivate the WiFi connection. You can then reactivate the WiFi connection to reconnect to the same network.

- On the dishwasher's control panel: Press and hold  for 8 seconds to deactivate the WiFi connection. Off appears on the display.
- On the dishwasher's control panel: Briefly press  to reactivate the WiFi connection. On appears on the display.



Remove devices

Remove all connected devices/users.

- On the dishwasher's control panel: Press and hold  for 4 seconds, then press and hold  for 3 seconds. UnP appears on the display, after which the display starts counting down.

Settings

Open the door and press .

To open the dishwasher's settings menu, press and hold  and  until SET is shown on the display.

Use  to step through the menu.



To exit the menu, step through it or press .

Settings	Alternatives	
2 Sounds	00 - 03	A beep confirms that the control panel has been pressed. A beep indicates when a dishwashing program has ended. <i>Error messages are always indicated by a loud buzzer.</i>
3 Rinse aid	00 - 05	Setting for rinse aid dosage. The rinse aid dispenser can be adjusted between 00 (Off) and 05 (High dosage). Increase the rinse aid dosage: <ul style="list-style-type: none"> If the dishes have water marks. Decrease the rinse aid dosage: <ul style="list-style-type: none"> If the dishes have a sticky white/blue film. If the dishes are streaked. Build-up of foam. If you have very soft water, the rinse aid can be diluted 50:50 with water. <i>Pre-selected at factory: 04</i>
4 Water hardness	00 - 09	Adjusting the water softener. Select a setting depending on the hardness of the water supply. It is important that this setting is correct! <i>See Water hardness in the chapter Before washing for the first time.</i> <i>For a water supply with a hardness below 6°dH (10°FH / 7°eH / 1.0 mmol/l), select 00. The water softener is deactivated and no salt needs to be added.</i> <i>Pre-selected at factory: 04</i>
5 TAB	00 (Off) 01 (On)	Activate this setting when using an all-in-one detergent that contains rinse aid. This setting reduces the rinse aid dosage and affects how often the dishwasher's built-in softener is regenerated.

Settings	Alternatives	
		<i>Pre-selected at factory: 00</i>
F--	Error readout	Any error messages. <i>When contacting the service department, you may be asked to provide the most recent error messages.</i>
rSt	Restore factory defaults	Restores all settings to the factory defaults. Select rSt and press \triangleright .
End	Exit	To exit the dishwasher's settings menu, select End and press \triangleright .

Care and cleaning

✧ Top up with rinse aid

When the rinse aid needs topping up, the above symbol lights on the display.

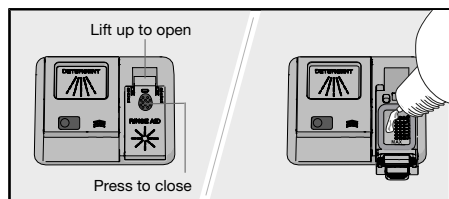

1. Open the rinse aid compartment lid.
2. Carefully top up with rinse aid to the level marked **MAX**.
3. Wipe up any splashes of rinse aid around the compartment.
4. Close the lid firmly.

After topping up, it may take a while before the symbol goes out.

⌘ Top up with salt

When the salt needs topping up, the above symbol lights on the display.

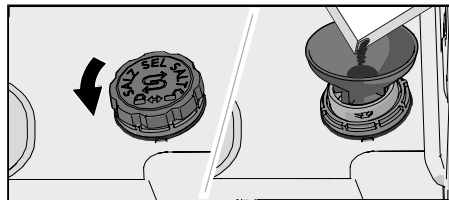

1. Remove the salt compartment lid by turning it anticlockwise.
2. Place the funnel supplied with the dishwasher in the salt compartment top-up hole. (Water is only needed the first time.)
3. Add enough salt to fill the salt compartment (max. 750 gram). Use special dishwasher salt.
4. Wipe up any excess salt so that the lid can be screwed on firmly.

After topping up, it may take a while before the symbol goes out.

⚠ **WARNING!**

In order to avoid rust stains a dishwashing program must be started immediately after adding salt.

Never pour dishwasher detergent into the salt compartment. This destroys the water softener!

Clean the filters

Coarse filter

The coarse filter traps larger food particles, which cannot get past the drainage pump. Empty the coarse filter when necessary. It should be cleaned at regular intervals depending on how often the dishwasher is used.

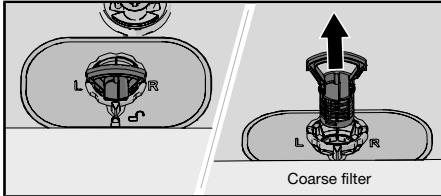

1. Lift the coarse filter by the handle.
2. Empty the coarse filter.
3. Refit the coarse filter. Press it down until it clicks into place.

Fine filter

Debris that collects on the fine filter is automatically rinsed away during each wash. Clean the fine filter when necessary. It should be cleaned at regular intervals depending on how often the dishwasher is used.

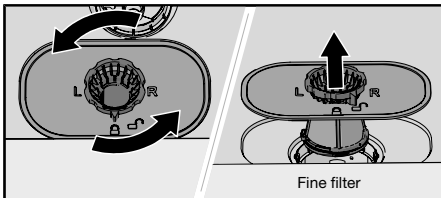

1. Turn the locking ring anticlockwise and lift the fine filter straight up.
2. Clean the fine filter.
3. Refit the fine filter and turn the locking ring clockwise to its stop position. Check that the edges seal properly.

Remember to refit the coarse filter!

NOTE!

Dishwashing results may be affected if the coarse and fine filters are incorrectly fitted. The dishwasher must not be used without the filters in place!

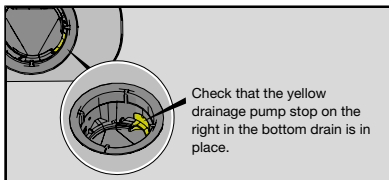

Cleaning the spray arms

Holes and bearings can sometimes become blocked. Remove any debris using a pin or the like. The spray arms also have holes underneath.

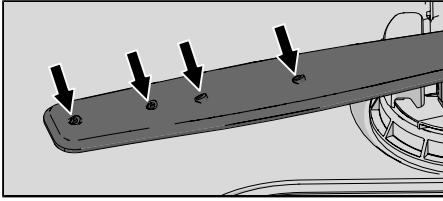

To facilitate cleaning you can remove the spray arms. Remember to fit them firmly back into place afterwards.

Top spray arm

- Pull out the top cutlery tray. Push up on the top spray arm while turning it anticlockwise to release it.

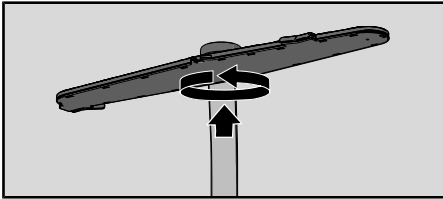

Upper spray arm

- Pull out the upper basket.
- Unscrew the spray arm bearings anticlockwise to remove the spray arm from the upper basket.

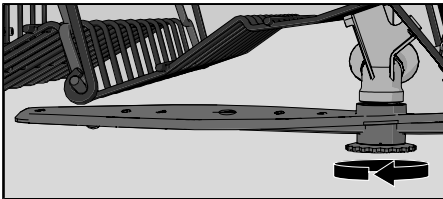

Lower spray arm

- Pull the lower spray arm straight up to release it.

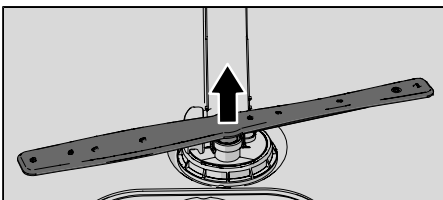

Clean the outside of the dishwasher

Door and door seal

Open the door. Clean the sides of the door and the door seal regularly with a slightly damp cloth. Clean the door seal at the lower front edge of the dishwasher with a washing-up brush.

Control panel

Keep the control panel clean. If necessary, wipe it with a dry or slightly damp cloth. Never use cleaning products – they may scratch the surface.

CLn - Run the Clean (Self-clean) program

Dishwasher tub

The dishwasher tub is made of stainless steel and is kept clean through normal use (when used regularly).

If you have hard water, limescale deposits may build up in the dishwasher. If this happens, run Self-clean with two tablespoons of citric acid in the detergent compartment (with no dishes in the machine). Special dishwasher cleaners are also available on the market.

Remove blockages

Unblocking the drainage pump

If the dishwasher still contains water after the program has finished, something may be blocking the drainage pump, which results in the Water outlet fault error message.

1. Turn off the machine using  and remove the plug from the wall socket.
2. Remove the coarse filter and the fine filter.
3. Scoop out the water from the dishwasher tub.
4. In order to inspect the drainage pump, remove the yellow drainage pump stop on the right in the bottom drain. (Use a pair of pliers if necessary.)
5. Turn the pump wheel located behind the drainage pump stop by hand. Carefully remove any sharp items, such as glass.
6. Refit the drainage pump stop along with the fine and coarse filters.
7. Plug the machine in again.

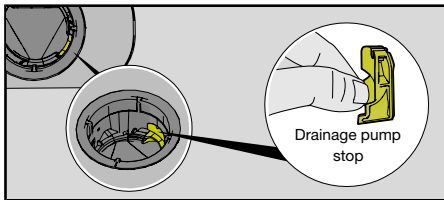

NOTE!

Do not forget to refit the drainage pump stop.

Unblocking the inlet hose filter

If the water supply contains small particles, the outer filter on the inlet hose may become blocked, which results in the Water inlet fault error message.

1. Turn off the machine using  and remove the plug from the wall socket.
2. Turn off the water tap.
3. Unscrew the inlet hose.

4. Carefully remove the outer filter from the inlet hose and clean it.
5. Refit the filter and check that the gasket is correctly positioned.
6. Screw the inlet hose firmly into place.
7. Plug the machine into the wall socket and turn on the water tap. Allow the pressure to settle for a while and check that the connection is watertight.

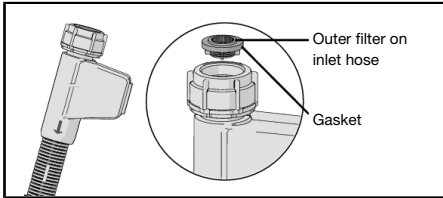





Troubleshooting

Error messages		Action
F10	Overfilling water	Clear the drainage pump. See the chapter <i>Care and cleaning</i> . If the problem persists, contact your nearest service centre.
F11	Water outlet fault	See "Water remains in the dishwasher" under "Problem" in the table below. If the problem persists, contact your nearest service centre.
F12	Water inlet fault	Check that the water tap is on. Check that the outer filter on the inlet hose is not blocked. See <i>Unblocking the inlet hose filter</i> in the chapter <i>Care and cleaning</i> . If the problem persists, contact your nearest service centre.
F40	Inlet valve leakage	Turn off the water tap and contact your nearest service centre.
F41	Heater fault 1	Turn off the water tap. Remove the plug from the wall socket and contact your nearest service centre.
F45	Diverter fault	Contact your nearest service centre.
F52	Water level fault	Clean the coarse and fine filters. Check that the outer filter on the inlet hose is not blocked. If the problem persists, contact your nearest service centre.
F54	Overfilling water	Turn off the water tap and contact your nearest service centre. To avoid water leakage outside the dishwasher, do not remove the plug from the wall socket until the water tap on the supply line has been turned off!
F56	Circulation pump fault	Contact your nearest service centre.
F67	Water inlet fault	Check that the water tap is on. Check that the outer filter on the inlet hose is not blocked. See <i>Unblocking the inlet hose filter</i> in the chapter <i>Care and cleaning</i> . If the problem persists, contact your nearest service centre.
F68	BLDC drain pump fault	Contact your nearest service centre.

Press any button to clear the error message.



General

Problem	Possible causes	Action
The control panel does not react when pressed.	You have pressed the control panel too soon after opening the door.	Wait a moment then try again.
	The door is closed.	Open the door. The control panel only reacts to use when the door is open.
	Dirt on the control panel.	Clean with a dry or slightly damp cloth.
Cannot close door.	The baskets are not correctly positioned.	Check that the baskets are correctly positioned horizontally.

Problem	Possible causes	Action
		Check that the dishes are not blocking the baskets from sliding properly into place.
	The door lock does not click into place and lock.	Check the door lock. If it does not click into place and lock, open the door. Press and hold  Auto Dry until the display starts counting down. Wait until the countdown ends (60 seconds). Close the door. Check that the door lock clicks into place and locks.
The dishwasher does not start.	 has not been pressed.	Press  . The display starts counting down.
	The door is not properly closed.	Check.
	You have opened the dishwasher to add more dishes while a program is in progress.	Close the door and wait. After a while, the dishwasher continues the program.
	The door lock has not clicked into place and locked.	Check the door lock. If it does not click into place and lock, open the door. Press and hold  Auto Dry until the display starts counting down. Wait until the countdown ends (60 seconds). Close the door. Check that the door lock clicks into place and locks.
	Check whether the Delayed start option has been selected.	Press and hold  for three seconds if you want to cancel the Delayed start option.
	The plug is not plugged into the wall socket.	Check.
	A fuse/circuit breaker has been tripped.	Check.
The dishes are not clean.	The spray arms do not rotate.	Check that the dishes are not blocking the spray arms.
	Spray arm holes or bearings blocked.	Clean the spray arms. See the chapter <i>Care and cleaning</i> .
	Unsuitable dishwashing program.	Select a program with a high temperature to dissolve grease on very dirty dishes, such as Intensive 70°.
	Incorrect detergent dosage.	Dose according to water hardness. Far too much or far too little detergent results in poorer dishwashing results.

Problem	Possible causes	Action
	Old detergent. Detergent is a perishable product.	Avoid large packages.
	Dishes loaded incorrectly.	Do not cover porcelain with large bowls or the like. Avoid placing very tall glasses in the corners of the baskets. See the chapter <i>Loading the dishwasher</i> .
	Glasses and cups have toppled over during the program.	Place dishes to sit steady.
	The filters are clogged.	Clean the coarse and fine filters.
	The filters are not fitted correctly.	Check that the filters are fitted correctly. See the chapter <i>Care and cleaning</i> .
	Drainage pump stop missing.	Check that the yellow drainage pump stop on the right in the bottom drain is in place. See the chapter <i>Care and cleaning</i> .
Spots on stainless steel or silver.	Some foodstuffs, such as mustard, mayonnaise, lemon, vinegar, salt and dressings, can cause spots on stainless steel if left for too long.	Rinse off these types of foodstuffs if not starting the dishwasher immediately. Consider using 1h 65° with the Speed wash option.
	All stainless steel can cause spots on silver if they come into contact during dishwashing. Aluminium can also cause spots on dishes.	In order to avoid marks and tarnishing, separate dishes made from different metals, such as silver, stainless steel and aluminium.
Spots or films on the dishes.	Incorrect rinse aid dosage setting.	See the chapter <i>Settings</i> .
	The setting TAB is activated and all-in-one detergent with insufficient drying effect is being used.	Switch all-in-one detergents or deactivate the TAB setting and top up with salt and separate rinse aid. See Rinse aid in the chapter <i>Settings</i> .
	Salt compartment empty.	Top up with salt. See the chapter <i>Before washing for the first time</i> .
	Incorrect water softener setting.	See Water hardness in the chapter <i>Settings</i> .
	The water softener is leaking salt.	Check that the salt compartment lid is properly tightened. Otherwise contact your nearest service centre.

Problem	Possible causes	Action
	Too high temperature and/or too much detergent can cause etching on crystal. Unfortunately, this cannot be repaired, only prevented.	Wash crystal at a low temperature and with a conservative amount of detergent. Contact the detergent manufacturer.
The dishes have a sticky white/blue film.	Rinse aid dosage setting too high.	Reduce the dosage. See the chapter <i>Settings</i> . If you have very soft water, you may want to dilute the rinse aid 50:50 with water.
Spots left after washing.	Lipstick and tea can be difficult to wash off.	Use a detergent with a bleaching agent.
Detergent residue in the detergent compartment after dishwashing.	The detergent compartment was damp when adding detergent.	The detergent compartment must be dry when adding detergent.
	The detergent compartment has been blocked.	Check that the dishes are not preventing the detergent compartment from opening.
Rattling sound when dishwashing.	The dishes are not correctly placed or the spray arms are not rotating.	Check that the dishes are placed securely. Spin the spray arms to make sure they can rotate.
Water remains in the dishwasher.	The filters are clogged.	Clean the coarse and fine filters.
	The filters are not fitted correctly.	Check that the filters are fitted correctly. See the chapter <i>Care and cleaning</i> .
	Debris in the drainage pump.	Clean the drainage pump. See the chapter <i>Care and cleaning</i> .
	Drainage pump stop missing.	Check that the yellow drainage pump stop on the right in the bottom drain is in place. See the chapter <i>Care and cleaning</i> .
	Kink in drainage hose.	Check that the hose is free from kinks and sharp bends.
	Blocked drainage hose.	Disconnect the drainage hose where it connects to the sink unit's water trap. Check that no debris has fastened and that the connection has an inner diameter of at least 14 mm.
Bad odour in dishwasher.	Dirt around the seals and in corners.	Clean with washing-up brush and low foaming cleaner.
	Low temperature programs have been selected for a prolonged period.	Run a program with a high temperature once or twice a month. Or run a self-cleaning program. See Self-clean in the chapter <i>Using the dishwasher</i> .

Problem	Possible causes	Action
Grease deposits in the dishwasher.	Low temperature programs have been selected for a prolonged period.	Select a program with a high temperature to dissolve grease on very dirty dishes, such as Intensive 70°. Or run a self-cleaning program. See Self-clean in the chapter <i>Using the dishwasher</i> .
The dishes are not dry enough.	The  Auto Dry option is not activated.	Activate the  Auto Dry option.
	The dishwasher is not fully loaded.	Fully load the dishwasher.
	Rinse aid needs topping up or dosage is set too low.	Top up with rinse aid or increase the rinse aid dosage setting.
	The setting TAB is activated and all-in-one detergent with insufficient drying effect is being used.	Switch all-in-one detergents or deactivate the TAB setting and top up with salt and separate rinse aid. See Rinse aid in the chapter <i>Settings</i> .

WiFi

Problem	Possible causes	Action
The dishwasher's network symbol  does not appear on the display.	The dishwasher is not connected to your wireless network.	Connect the dishwasher to your wireless network. See the chapter <i>WiFi connection</i> .
	The WiFi connection is deactivated.	Activate the WiFi connection. See <i>Deactivate/activate WiFi connection</i> in the chapter <i>WiFi connection</i> .
WiFi connection failed	The dishwasher cannot access your wireless network. Or the router is not connected to the internet.	Check that the router is connected to the internet.
		Make sure your wireless network is using 2.4 GHz and is visible. Try moving the router closer to the dishwasher if the signal is too weak.
		See also troubleshooting at www.connectlife.io . If the problem persists, contact your nearest service centre.
Pairing failed	Your smartphone/tablet is not connected to your wireless network. Or the router is not connected to the internet.	Check that the router is connected to the internet.
		Check that your smartphone/tablet is connected to your wireless network.
		See also troubleshooting at www.connectlife.io . If the problem persists, contact your nearest service centre.
The dishwasher is shown as disconnected in the <i>ConnectLife app</i> .	The WiFi connection is deactivated	Activate the WiFi connection. See <i>Deactivate/activate WiFi connection</i> in the chapter <i>WiFi connection</i> .
		See also troubleshooting at www.connectlife.io . If the problem persists, contact your nearest service centre.
Software update failed.	The network connection was lost or the dishwasher lost power due to a power failure.	Make sure that the power supply is not interrupted and that the network connection is stable before trying again. If the problem persists, contact your nearest service centre.

Installation

It is important that you read through and follow the instructions and directions below. Conduct installation and connection in accordance with the separate installation instructions.

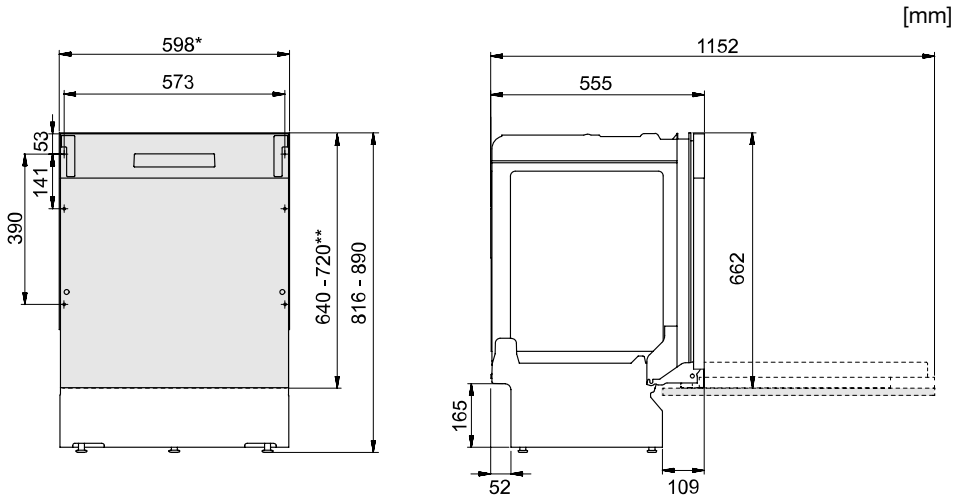

*Remove the plastic strips if the recess dimension is 596-598 mm.
Exercise caution! The edges may be sharp. Wear protective gloves!

**Cover door length.

Nominal dimensions. Actual measurements may vary.

Safety instructions

- Connections to electricity, water and drainage must be performed by a qualified professional.
- Always follow applicable regulations for water, drainage and electricity.
- Take care during installation! Wear protective gloves! There must always be two people!
- Place a drip tray on the floor beneath the dishwasher to prevent damage from any water leaks.
- Before screwing the dishwasher into place, test the dishwasher by running the 1h 65° program with the Speed wash option. Check that the dishwasher fills with water and drains. Check also that none of the connections leak.

WARNING!

Turn off the water supply when installing the dishwasher!

The plug must be disconnected or power to the socket turned off while the work is carried out!

Setup

- The recess and connection dimensions are included in the separate installation instructions. Check that all dimensions are correct before starting the installation. Note that the height of the cover door can be adjusted to match other fittings.
- Make sure the area on which the dishwasher is to be installed is firm. Adjust the adjustable feet so that the dishwasher is level.

- If the dishwasher is built-in the surrounding furnishings must be resistant to any condensation from the dishwasher.
- Mount the protective film beneath the worktop and up around the edge. The function of the protective film is to protect the worktop from moisture. (The protective film is in the enclosed plastic bag.)
- Check that the machine is installed such that the door opens freely, otherwise door lock functionality may be disrupted.
- Note that the door springs may need adjusting after a cover door has been fitted. Adjust the left and right door springs equally until the door is evenly balanced.

Drainage connection

This dishwasher is suitable for installing in a raised recess (to attain an ergonomic working height). This means that the dishwasher can be placed so that the drainage hose runs to a lower level than the bottom of the dishwasher, such as by routing it directly to a floor drain. The dishwasher is fitted with an integrated anti-siphon device to prevent the machine from being emptied of water during the wash cycle.

The drainage hose can also be connected to a connection nipple on the sink unit's water trap. The connection nipple must have an internal diameter of at least 14 mm.

The drainage hose may be extended by a maximum of 3 m (the total length of the drainage hose must not exceed 4.5 m). Any joins and connecting pipes must have an internal diameter of at least 14 mm. However, the drainage hose should ideally be replaced with a new hose without joins.

No part of the drainage hose may be more than 950 mm above the bottom of the dishwasher.

Attach the drainage hose with a hose clamp. Ensure that the drainage hose has no kinks.

Connection to water supply

Use only the inlet hose supplied with the dishwasher. Do not re-use old or other spare hoses.

The supply pipe must be fitted with a water tap (stopcock). The water tap must be easily accessible, so that the water can be shut off if the dishwasher has to be moved.

Once the installation is complete, turn on the water tap and allow the pressure to settle for a while. Check that all connections are watertight.

Connection to cold water supply

Connect the dishwasher to the cold water supply if the building is heated using oil, electricity or gas.

Connection to hot water supply

Connect the dishwasher to the hot water supply (max. 70 °C) if the building is heated using an energy-efficient means such as district heating, solar power or geothermal power. Choosing a hot water connection reduces the dishwasher's energy consumption.

NOTE!

Do not exceed the permitted water supply temperature. Certain materials used in some cookware cannot withstand high heat. See *Fragile dishes* in the chapter *Loading the dishwasher*.

Electrical connection

Information about the electrical connection can be found on the serial number plate. This specification must match the electricity supply.

The dishwasher must be connected to an earthed socket.

The electric wall socket must be placed outside of the installation area to be easily accessible after installing the dishwasher. Do not use an extension cord!

Service

Read the chapter *Troubleshooting* before contacting the service centre. If you have encountered a problem that you cannot resolve, please contact your nearest service centre for professional help, see www.hisense.com. Our website also has information about spare part availability and what you can repair yourself.

When making contact, provide the details on the serial number plate. Include the article number (1) and the serial number (2).

Please note that non-professional repairs may risk user safety and affect the warranty.

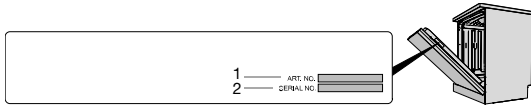

Technical data and energy labelling

Technical data

Height:	816-890 mm
Width:	598 mm
Depth:	555 mm
Weight:	30 kg ¹⁾
Number of standard place settings:	16 ²⁾
Water pressure:	0.03-1.0 MPa
Electrical connection:	See the serial number plate
Rated power:	See the serial number plate

1) *Weight can vary due to different specifications.*

2) *In accordance with the EN 60436 standard.*

Information for consumers

Information about your product can be found at global.hisense.com, where you will also find a link to the European Product Database for Energy Labelling, EPREL. Or else visit <https://eprel.ec.europa.eu> directly. Follow the instructions to search by model name.

See the information on the serial number plate. Make a note of the model name (3).

Information for test institute

Information about this product can be found in the European Product Database for Energy Labelling, EPREL, and can also be ordered by e-mail dishwashers@appliance-development.com.

The request should include the details on the serial number plate. Include the article number (1), the serial number (2) and the model name (3).

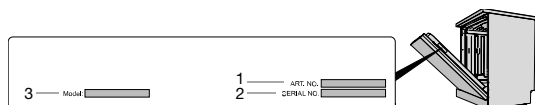

EU declaration of conformity

ASKO Appliances Inc. confirms that the product with a network connection to *ConnectLife* conforms to all legal requirements for the product set out in directive 2014/53/EU. For more information, please visit www.hisense.com.

Network connection power usage	Network standby:	< 2.00 W
	Time before network standby:	2 minutes

Hisense



873906-a2



We reserve the right to make changes.